

UPM309

Universal Power Meter



USER MANUAL

Use & Programming
MODBUS Protocol

Limitation of Liability

The Manufacturer reserves the right to modify the specifications in this manual without previous warning. Any copy of this manual, in part or in full, whether by photocopy or by other means, even of electronic nature, without the manufacture giving written authorisation, breaches the terms of copyright and is liable to prosecution.

It is absolutely forbidden to use the device for different uses other than those for which it has been devised for, as inferred to in this manual. When using the features in this device, obey all laws and respect privacy and legitimate rights of others.

EXCEPT TO THE EXTENT PROHIBITED BY APPLICABLE LAW, UNDER NO CIRCUMSTANCES SHALL THE MANUFACTURER BE LIABLE FOR CONSEQUENTIAL DAMAGES SUSTAINED IN CONNECTION WITH SAID PRODUCT AND THE MANUFACTURER NEITHER ASSUMES NOR AUTHORIZES ANY REPRESENTATIVE OR OTHER PERSON TO ASSUME FOR IT ANY OBLIGATION OR LIABILITY OTHER THAN SUCH AS IS EXPRESSLY SET FORTH HEREIN.

All trademarks in this manual are property of their respective owners.

The information contained in this manual is for information purposes only, is subject to changes without previous warning and cannot be considered binding for the Manufacturer. The Manufacturer assumes no responsibility for any errors or incoherence possibly contained in this manual.

MANUAL

Use & Programming

5

MODBUS

Communication Protocol

47

MANUAL

Use & Programming

INDEX • Use&Programming

1. Introduction	7
2. Graphic symbols	7
3. Preliminary verification	8
4. General description	8
5. Installation	9
5.1 ENVIRONMENTAL REQUIREMENTS.....	9
5.2 MOUNTING.....	9
6. Safety measures	9
7. Electrical connections	10
7.1 CURRENT AND VOLTAGE INPUTS	10
7.2 AUXILIARY POWER SUPPLY	11
7.3 RS485 COMMUNICATION PORT	12
7.4 ETHERNET COMMUNICATION PORT	13
7.5 DIGITAL OUTPUTS	14
7.6 DIGITAL INPUT	14
7.7 ANALOG OUTPUT	14
8. Use and configuration.....	15
8.1 SYMBOLS ON DISPLAY	15
8.2 PAGE STRUCTURE	17
8.3 HOME PAGE	17
8.4 LOOP 1 - REAL TIME VALUES	18
8.5 MEASUREMENT OVERFLOW	19
8.6 REAL TIME MIN/MAX VALUES	19
8.7 REAL TIME PARAMETER TABLE.....	19
8.8 LOOP 2 - DMD VALUES	21
8.9 DMD MAX VALUE	21
8.10 DMD PARAMETER TABLE.....	22
8.11 LOOP 3 - HARMONIC VALUES	23
8.12 HARMONIC PARAMETER TABLE	25
8.13 LOOP 4 - ENERGY COUNTERS.....	26
8.14 ENERGY COUNTER TABLE	28
8.15 LOOP 5 - SETUP	30
8.16 LOOP 6 - INFO	44
9. Technical specifications.....	45

1. INTRODUCTION

This manual provides information on the installation, configuration and use of the instrument functions.

The manual is not intended for general use, but for qualified technicians. This term indicates a professional and skilled technician, authorised to act in accordance with the safety standards relating to the dangers posed by electric current. This person must also have basic first aid training and be in possession of suitable Personal Protective Equipment.



WARNING! It is strictly forbidden for anyone who does not fulfill the above-mentioned requirements to install or use the instrument.

The instrument complies with the European Union directives in force, as well as with the technical standards implementing these requirements, as certified by the CE mark on the device and on this Manual.

Using the meter for purposes other than intended ones, understood by the manual content, is strictly forbidden.

The information herein contained shall not be shared with third parties. Any duplication of this manual, either partial or total, not authorised in writing by the Manufacturer and obtained by photocopying, duplicating or using any other electronic means, violates the terms of copyright and is punishable by law. Any brands quoted in the publication belong to the legitimate registered owners.

2. GRAPHIC SYMBOLS

On the manual some instructions are highlighted by graphic symbols to draw the reader's attention on the operational dangers. The following graphic symbols are used:



DANGER! This warning indicates the possible presence of dangerous voltage on the marked terminals (even if for short periods).



WARNING! This warning indicates the possible occurrence of an event which may cause a serious accident or considerable damage to the device if suitable precautionary countermeasures are not taken.



NOTE. This symbol indicates important information which must be read carefully.

3. PRELIMINARY VERIFICATION



NOTE. At the opening of the box, check that the instrument has not been damaged during transport. If the instrument appears to be damaged, contact the technical after-sales service.

The box contains:

- the instrument
- the quick guide
- no. 2 mounting clips
- no. 3 Rogowski coils (only for instrument with Rogowski inputs)

4. GENERAL DESCRIPTION

The instrument is a digital meter able to measure the electrical parameters on three-phase systems. It provides accurate measurements even by distorted waveform.

LCD display provides the three-phase quantities. The working parameters can be easily set up by instrument keypad.

The instrument is a compact, cost effective meter operating both as a stand-alone device or as an integral part of a more extensive energy monitoring and management network.

The instrument replaces multiple analog meters as well as single function meters such as voltmeters, ammeters, wattmeters, varmeters, frequency-meters, powerfactor-meters, energy-meters, etc.

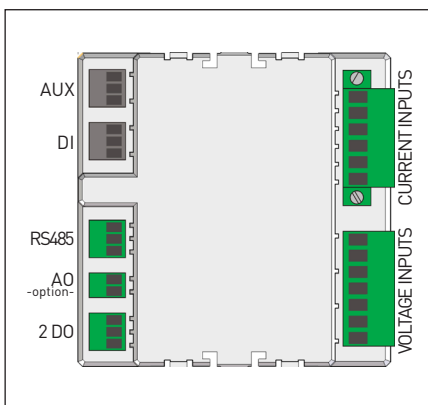
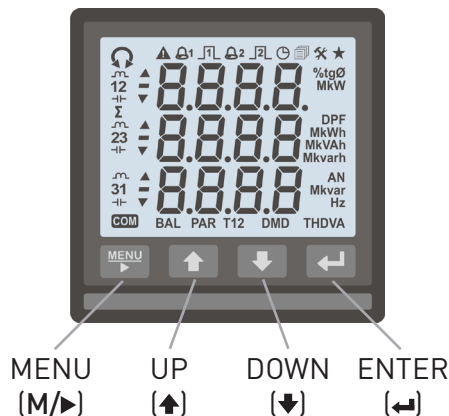

RS485 model

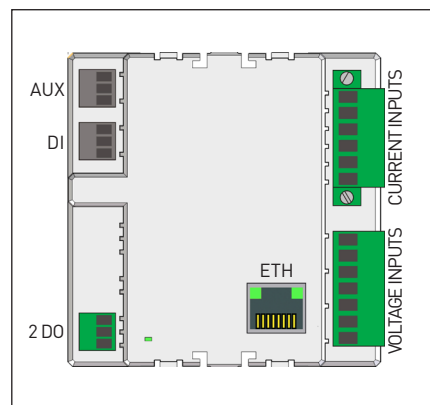

ETHERNET model

5. INSTALLATION



NOTE. The equipment complies with the 89/366/EEC, 73/23/EEC standards and following amendments. However, if not properly installed, it may generate a magnetic field and radio interference. This is why compliance with EMC standards on electromagnetic compatibility is essential.

5.1 ENVIRONMENTAL REQUIREMENTS

The environment in which the instrument is installed must satisfy the following features:

- indoor area
- operating temperature between -25°C and $+55^{\circ}\text{C}$
- max humidity 80% (no condensation)
- up to 2000 m altitude AMSL



NOTE. The instrument must not be exposed to sun rays.

5.2 MOUNTING

The instrument is for 96x96 panel mounting. Follow the instructions:

1. In the panel, make a square cutout 91x91 mm (tolerance: $+0.8...-0$ mm).
2. Insert the instrument through the cutout.
3. Fix the two mounting clips to the instrument as shown.

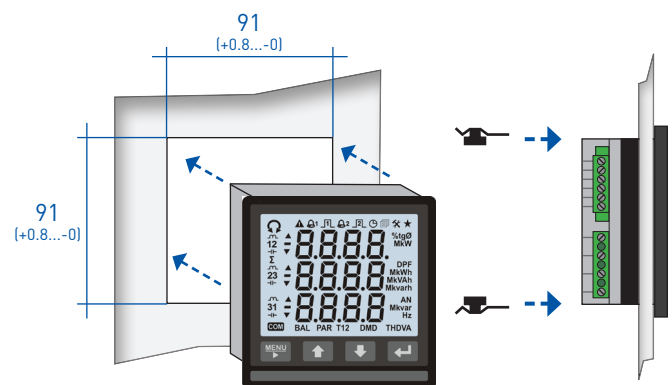

6. SAFETY MEASURES



DANGER! This warning means that a dangerous voltage may be present on the terminals even for short periods.



WARNING! Electrical instrument connections must be carried out only by skilled technicians who are aware of the risks involved to the presence of voltage.

Before connecting, check the following:

1. The conductor wires are not powered.
2. The instrument is connected according to the appropriate diagram.
3. The power supply corresponds to the values on the instrument specification.
4. The instrument has been installed in a vibration-free and a suitable temperature environment.
5. The terminals are no longer accessible after being connected.
6. The wiring is carried out in accordance with the standards in force in the Country where the instrument will be installed.
7. A circuit breaker and an over-current device (eg. 250 mA T type fuse) are installed between the instrument power supply and the electrical system.
8. The connections are made respecting the polarities. Important: L1 of the voltage input = L1 of the amperometric input.
9. Input and output polarities are respected when using current&voltage transformers, Rogowski coils.
10. The terminals are fixed in such a way that the connection wires cannot be accidentally disconnected.

7. ELECTRICAL CONNECTIONS

WARNING! The instrument installation and use must be carried out only by qualified staff. Switch off the voltage before device installation.

7.1 CURRENT AND VOLTAGE INPUTS

DANGER! This section describes the measurement voltage and current inputs susceptible to dangerous voltage levels.

WARNING! Before carrying out connections, check if there is no voltage/current in the conductor wires. **DO NOT CONNECT** conductors under voltage/current.

According to the instrument model, the current input type is for 1/5A CTs or Rogowski coils. Check the instrument model and connect the voltage and current inputs according to the following wiring diagrams.

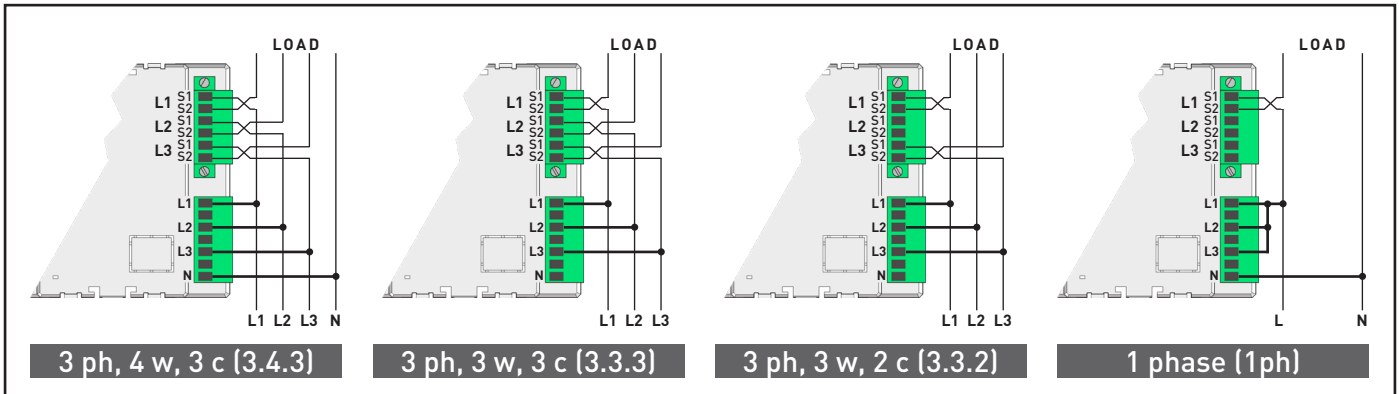

1/5A CT model with direct connection

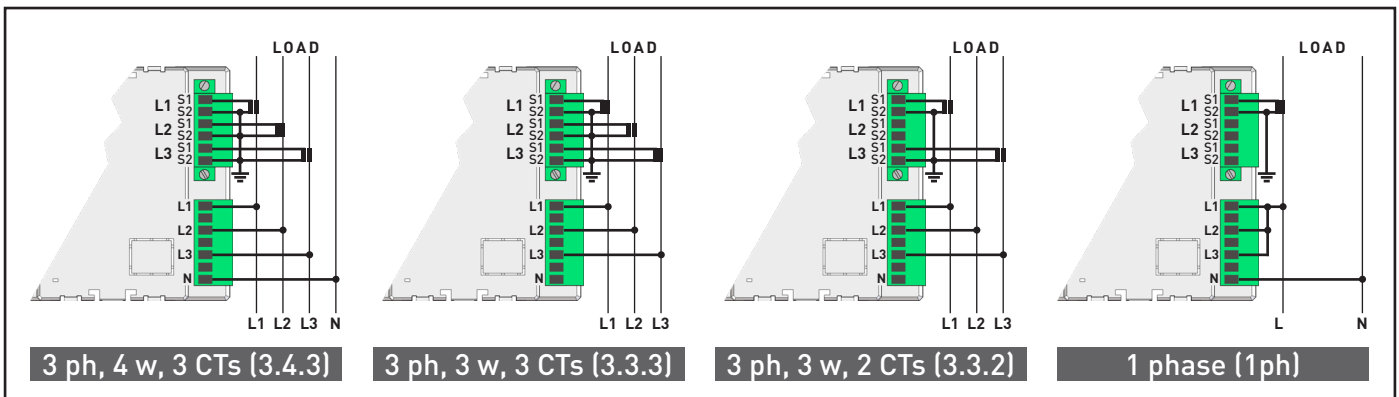

1/5A CT model with current transformer connection

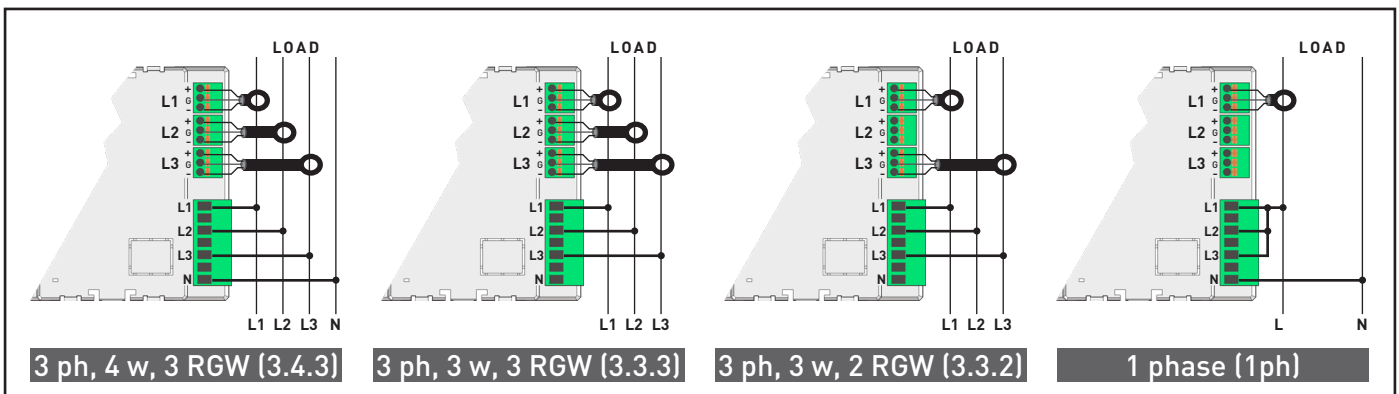

Rogowski model connection

For Rogowski coil wiring, connect the white wire to the **+** terminal, the shield to the **G** terminal and the blue wire to the **-** terminal. Refer to the following picture.

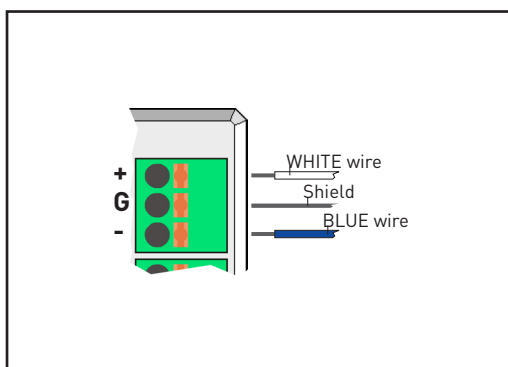

Detail of Rogowski coil connection



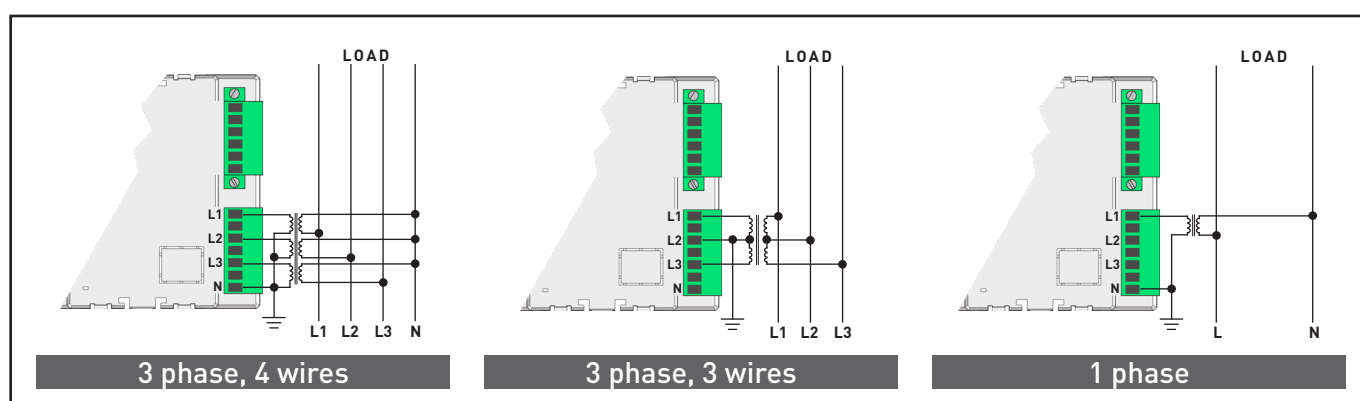

The following voltage transformer connections are available.



1/5A CT or Rogowski model with voltage transformer connection

For wiring mode selection, refer to section 8.15.1.

7.2 AUXILIARY POWER SUPPLY

-  **DANGER!** This section describes the AUX supply input susceptible to dangerous voltage levels.
-  **WARNING!** Before carrying out connections, check if there is no voltage/current in the conductor wires. **DO NOT CONNECT** conductors under voltage/current.
-  **WARNING!** Install a circuit breaker and an over-current device (eg. 250 mA T type fuse) between the instrument power supply and the electrical system.
-  **WARNING!** Before connecting the instrument to the network, check the network voltage corresponds to the value on the instrument.

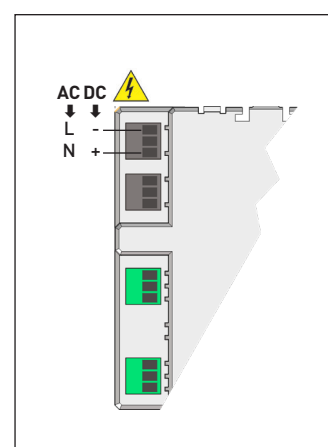

AUX power input

The instrument can be supplied in one of the following modes, according to the model:

- 230 VAC $\pm 15\%$ (only for RS485 model)
- 115 VAC $\pm 15\%$ (only for RS485 model)
- 85...265 VAC / 110 VDC $\pm 15\%$ (only for model without analog output)

Check the value on the instrument back side.

7.3 RS485 COMMUNICATION PORT

WARNING! Before carrying out connections, check if there is no voltage/current in the conductor wires. **DO NOT CONNECT conductors under voltage/current.**

NOTE. The RS485 port is available according to the instrument model.

The RS485 serial communication port allows to manage the instrument in local or remote mode by PC.

For a local connection, a converter is needed to adapt the PC USB port to the RS485 network.

The RS485 standard interface allows a multi-point connection. If there are more than 32 instruments to be connected, insert a signal repeater. Each repeater can manage up to 32 instruments.

The connection provides a third conductor to the terminal (COM) to ensure the same reference level to all network devices.

When there are strong electromagnetic disturbances, which may affect communication, a shielded cable (with two twisted signal conductors) should be used. The terminal resistances ($RT=120\dots150\Omega$) must be installed on the converter side and on the last instrument connected along the line. Thanks to these resistances, the reflected signal along the line is reduced. However, in case of short distances (max 100 m) or low communication speed (bps) there is no need of resistances.

NOTE. The value of each resistance must not be lower than $120\ \Omega$ in order to avoid an overload of line drivers.

The maximum recommended distance for a connection is 1200m at 9600 bps. For longer distances, lower communication speed (bps), low-attenuation cables or signal repeaters are needed.

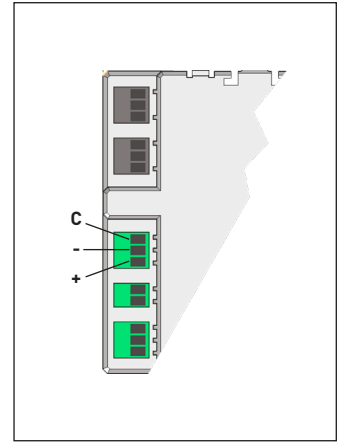

RS485 port

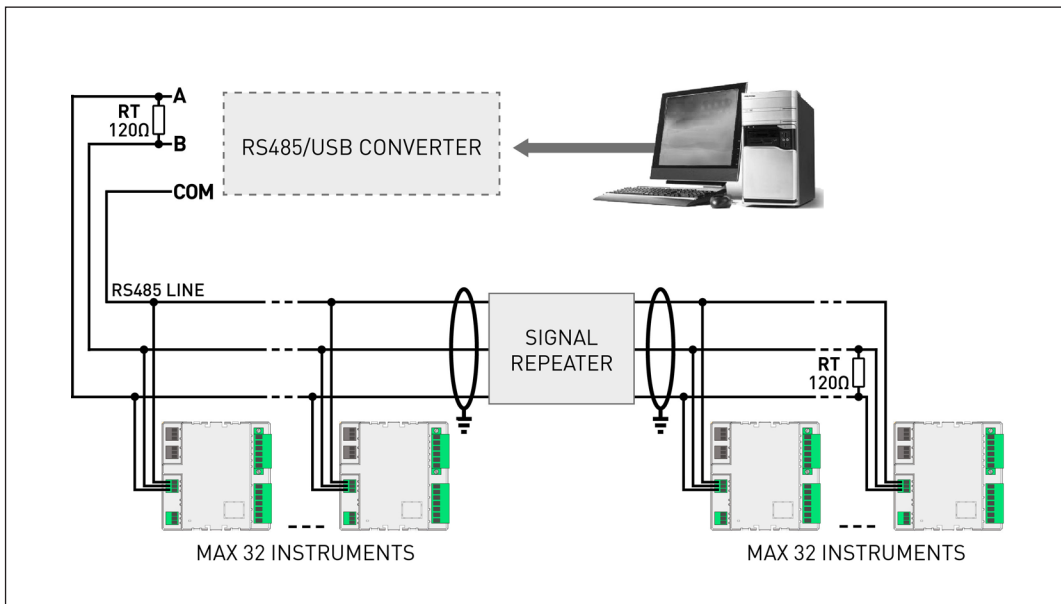

Connection to the RS485 network

For communication settings (speed, MODBUS address) refer to sections 8.15.7, 8.15.8.

7.4 ETHERNET COMMUNICATION PORT



WARNING! Before carrying out connections, check if there is no voltage/current in the conductor wires. **DO NOT CONNECT conductors under voltage/current.**



NOTE. The **ETHERNET** port is available according to the instrument model.

The ETHERNET communication port gives the possibility to manage the instrument by any PC connected on the ETHERNET/Internet network. The instrument communication can be also performed by MODBUS TCP protocol, by using the same registers common for MODBUS RTU.

The ETHERNET interface default IP address is **192.168.1.249**. The PC network interface must have the same address class (192.168.1.xxx). If the PC address has a different address class, contact your network system administrator.

By inserting the instrument IP address or the preset name ETHBOARD in the web browser, the instrument Web server will be displayed. Default administrator access level username and password: admin, admin.

The instrument web pages are designed to be cross browser compliant: Internet Explorer 11, Mozilla Firefox 27, Apple Safari 5, Google Chrome 33, Opera 20 are all supported web browsers. Furthermore, Web server can be also displayed on the common smartphones and tablets.

Web server has been designed for two user type:

- Administrator: full Web server use. Instrument management, setup, upgrade as well as access account configuration.
- User: limited Web server use (possibility to have up to 5 User accounts).

LED meaning & diagnostic:

1. **STATUS LED:** communication status; SLOW BLINKING=internal communication ok, ON=switching on or upgrading in progress, FAST BLINKING=internal communication error
2. **SPEED LED:** communication speed; OFF=10 Mbps, ON=100 Mbps
3. **LINK LED:** link activity; ON=link ok, BLINKING=link activity

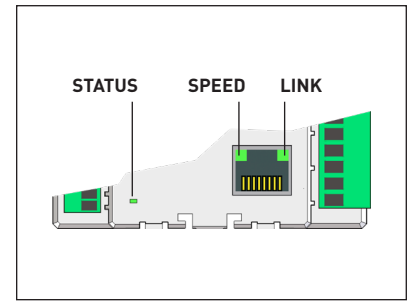

ETHERNET port & LEDs

7.5 DIGITAL OUTPUTS

WARNING! Before carrying out connections, check if there is no voltage/current in the conductor wires. **DO NOT CONNECT conductors under voltage/current.**

WARNING! Before connecting the digital outputs, check if the wiring configuration is NPN or PNP. Refer to the instrument back side in order to identify the model.

The instrument is provided with two passive optoisolated digital outputs for pulse emission or alarm (27 VDC-27mA maximum value). According to the model, digital outputs can be NPN or PNP.

For digital output setup, refer to section 8.15.10.

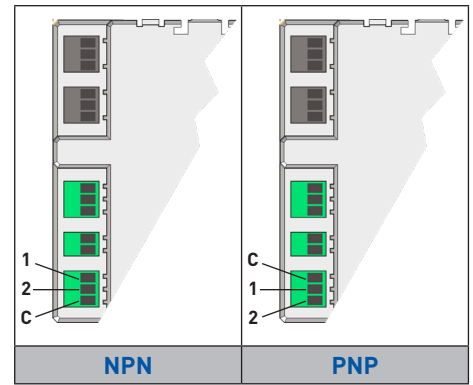

Digital outputs

7.6 DIGITAL INPUT

WARNING! Before carrying out connections, check if there is no voltage/current in the conductor wires. **DO NOT CONNECT conductors under voltage/current.**

The instrument is provided with an active optoisolated digital input to synchronise the Demand (DMD) value calculation (80...265 VAC-DC).

To set the digital input synchro mode for the DMD value calculation, refer to section 8.15.12.

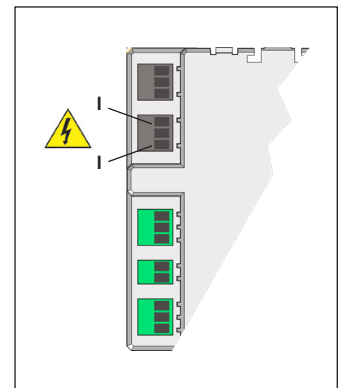

Digital input

7.7 ANALOG OUTPUT

WARNING! Before carrying out connections, check if there is no voltage/current in the conductor wires. **DO NOT CONNECT conductors under voltage/current.**

NOTE. This feature is available only on request for ENH instrument version with RS485 port.

The instrument can be provided on request with an active optoisolated analog output for signal transmission to an external control device (0...20 / 4...20 mADC, selectable).

For analog output setup, refer to section 8.15.11.

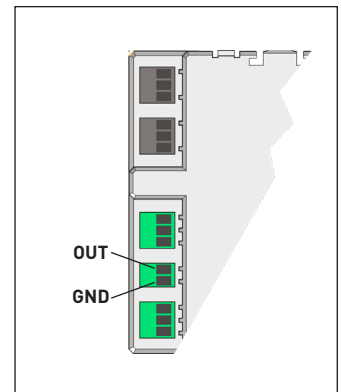

Analog output

8. USE AND CONFIGURATION

At first instrument power on, the following pages will be displayed.



The page sequence is the same for the further power on times, except for Real time value page. After Firmware release page, it will be displayed:

- Home page (if set).
- Last page displayed before switching off (if no Home page is set).



NOTE. At instrument power on, the display is backlighted. After 30 s of instrument keyboard inactivity, the backlight goes off automatically. Press any key to turn on the backlight again.

8.1 SYMBOLS ON DISPLAY

The display test can be performed, on any page except for Setup pages, by pressing simultaneously \uparrow , \downarrow and \leftarrow buttons for at least 10 s.

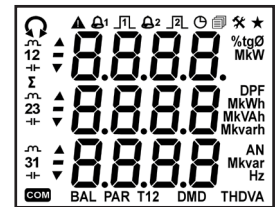

SYMBOL	MEANING	WHERE
Ω	Phase sequence status	
Ω	Correct phase sequence (123/CCW).	Measurement pages
Ω	Wrong phase sequence (132/CW).	Measurement pages
Ω ▲ BLINKING	Undefined phase sequence (e.g. 2 phases are shortcircuited, 1 or more phases are missing).	Measurement pages
NOT DISPLAYED	Single phase insertion.	Measurement pages
$\mathcal{A}1$ ($\mathcal{A}2$)	Info/status on digital output 1 (or 2) in Alarm mode	
$\mathcal{A}1$	Setup page for digital output 1 in Alarm mode.	Setup, page for digital output 1 in alarm mode
	Active alarm for digital output 1.	Measurement pages
$\mathcal{A}2$	Setup page for digital output 2 in Alarm mode.	Setup, page for digital output 2 in alarm mode
	Active alarm for digital output 2.	Measurement pages
$\mathcal{P}1$ ($\mathcal{P}2$)	Info/status on digital output 1 (or 2) in Pulse mode	
$\mathcal{P}1$	Setup page for digital output 1 in Pulse mode.	Setup, page for digital output 1 in pulse mode
	Pulse emission on digital output 1.	Measurement pages
$\mathcal{P}1$ FAST BLINKING	Pulse overlapping on digital output 1.	Measurement pages
$\mathcal{P}2$	Setup page for digital output 2 in Pulse mode.	Setup, page for digital output 2 in pulse mode
	Pulse emission on digital output 2.	Measurement pages
$\mathcal{P}2$ FAST BLINKING	Pulse overlapping on digital output 2.	Measurement pages

SYMBOL	MEANING	WHERE
	General warning	
	Overtaken measurement fullscale.	Measurement pages
	Too high CT*PT product or FSA*PT product.	Setup, during CT, FSA, PT setup
	Full memory, data recording is stopped (FILL recording mode).	Any page except Setup
	Undefined phase sequence (e.g. 2 phases are shortcircuited, 1 or more phases are missing).	Measurement pages
	Clock status	
	Setup page for date and time.	Setup, page for date&time
	Info page for date and time.	Info, page for date&time
	Undefined date and time (no clock setup after power on).	Any page except Setup
	Memory/data recording status	
	Setup page for data recording.	Setup, page for data recording
	Active data recording.	Any page except Setup
	Full memory (RING recording mode).	Any page except Setup
	Full memory, data recording is stopped (FILL recording mode).	Any page except Setup
	Setup pages	Any page of Setup
	Home page	
	The displayed page is set as Home page.	Home page
	Communication status	
	Page for communication parameters.	Setup, Baud, Par, Addr, Eth pages
	Active communication.	Any page except Setup
	Inductive and capacitive values	
	Inductive value.	Energy counters, power factors, reactive powers, DPF
	Capacitive value.	Energy counters, power factors, reactive powers, DPF
	Maximum & minimum values	
	Maximum value.	Real time value pages
	Maximum demand (DMD) value.	DMD value pages
	Minimum value.	Real time value pages

8.2 PAGE STRUCTURE

Up to 6 page loops can be available on the the instrument display, according to the model. With **M/▶** button change the loop. The loop 5 (Setup) is protected by password, for further details see section 8.15. Use **▲** or **▼** button to scroll pages inside each loop.

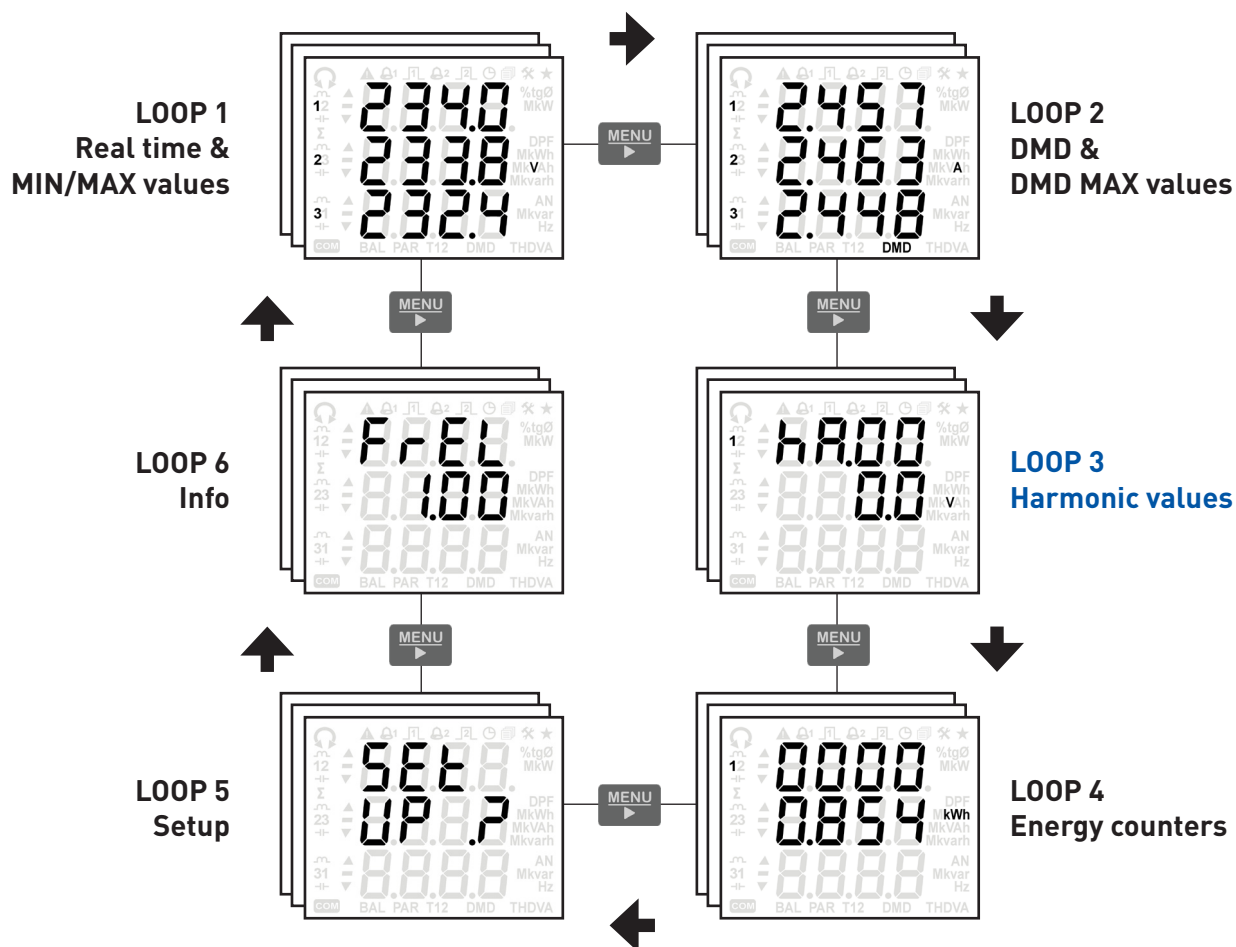

8.3 HOME PAGE

The Home page is a preset page displayed after 2 minutes of instrument keyboard inactivity. Only measurement pages can be set as Home page.

To set the displayed page as Home, press **◀** button for at least 5 s, the **★** symbol will be shown to indicate that Home page was set. To disable it, on the Home page press **◀** button for at least 5 s, the **★** symbol will disappear.

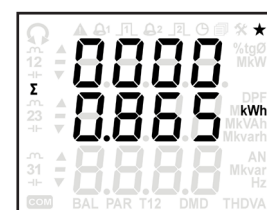

8.4 LOOP 1 - REAL TIME VALUES

In this loop, the real time and the corresponding min/max values are displayed according to the instrument model and the set wiring mode.

Scroll the loop pages with **▲** or **▼** button.

The following pages refer to the full optional instrument version with 3 phase, 4 wire, 3 current insertion.



NOTE. The pages with the THD or DPF parameters can display “_ _ _ _” instead of values, when the voltage or current RMS values are lower than the threshold values defined for FFT calculation (refer to chapter 9).



<p>1</p>	 	<p>2</p>	 	<p>3</p>
<p>4</p>	 	<p>5</p>	 	<p>6</p>
<p>7</p>	 	<p>8</p>	 	<p>9</p>
<p>10</p>	 	<p>11</p>	 	<p>12</p>
<p>13</p>	 	<p>14</p>	 	<p>15</p>
<p>16</p>	 	<p>17</p>	 	<p>18</p>

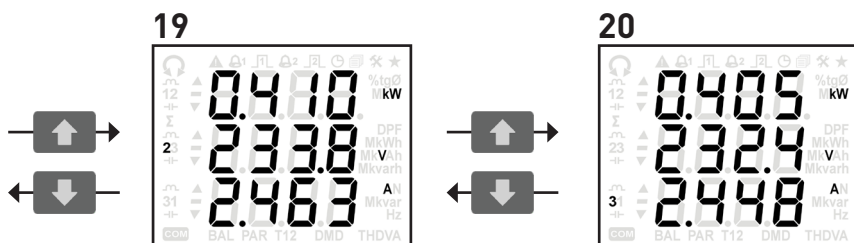

8.5 MEASUREMENT OVERFLOW

According to EN 61010-2-030, in case of too high value supplied to the device, the display must inform the user precisely that it is a dangerous overflow (OVF) situation. When an overflow condition occurs, for the relative parameter “----” and ▲ symbol are blinking on display. Max limit values for voltages and currents over which OVF indication occurs:

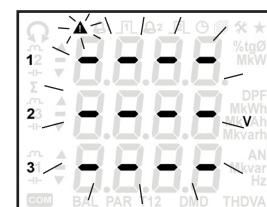

	1/5A CTs model	Rogowski model	
V (Line-Neutral)	300 VRMS	300 VRMS	
A (Line)	7.5 A	700 A	→ with 500 A scale
		5600 A	→ with 4000 A scale
		28000 A	→ with 20000 A scale

The overflow condition can be detected also in MODBUS protocol, by reading the \$201C register. This register gives the possibility to know if the overflow occurs, with no indication on the parameters involved in this condition.

8.6 REAL TIME MIN/MAX VALUES

To show the maximum values of the displayed real time parameters (except for DPF and frequency values), press ▲ and ← buttons simultaneously for at least 2 s. The “▲” symbol will start to blink and the maximum values will be displayed for about 6 s (in case of bidirectional parameters, the imported values will be displayed in the first 3 s while the exported values in the following 3 s).



Minimum values are available only for system powers. To show the minimum values of the displayed system powers, press ▼ and ← buttons simultaneously for at least 2 s. The “▼” symbol will start to blink and the minimum values will be displayed for about 6 s.



8.7 REAL TIME PARAMETER TABLE

The following table shows the parameters available according to the instrument model and the set wiring mode. The column “DISPLAY PAGE” shows the number of the corresponding device page shown in section 8.4.

PARAMETER	DISPLAY PAGE	MAX (▲) VALUE	MIN (▼) VALUE	WIRING MODES (●=available)			
				3ph, 4w, 3c	3ph, 3w, 3c	3ph, 3w, 2c	1phase
V1 • Phase 1-N voltage	1	▲		●			●
V2 • Phase 2-N voltage	1	▲		●			
V3 • Phase 3-N voltage	1	▲		●			
V12 • Line 12 voltage	2	▲		●	●	●	
V23 • Line 23 voltage	2	▲		●	●	●	
V31 • Line 31 voltage	2	▲		●	●	●	
VΣ • System voltage	4	▲		●	●	●	

PARAMETER	DISPLAY PAGE	MAX (▲) VALUE	MIN (▼) VALUE	WIRING MODES (●=available)			
				3ph, 4w, 3c	3ph, 3w, 3c	3ph, 3w, 2c	1phase
A1 • Phase 1 current	3	▲		●	●	●	●
A2 • Phase 2 current	3	▲		●	●	●	
A3 • Phase 3 current	3	▲		●	●	●	
AN • Neutral current *	5	▲		●			
A Σ • System current	5	▲		●	●	●	
P1 • Phase 1 active power	6	▲ (+/-)		●			●
P2 • Phase 2 active power	6	▲ (+/-)		●			
P3 • Phase 3 active power	6	▲ (+/-)		●			
P Σ • System active power	9	▲ (+/-)	▼	●	●	●	
S1 • Phase 1 apparent power	7	▲ (+/-)		●			●
S2 • Phase 2 apparent power	7	▲ (+/-)		●			
S3 • Phase 3 apparent power	7	▲ (+/-)		●			
S Σ • System apparent power	9	▲ (+/-)	▼	●	●	●	
Q1 • Phase 1 reactive power	8	▲ (+/-)		●			●
Q2 • Phase 2 reactive power	8	▲ (+/-)		●			
Q3 • Phase 3 reactive power	8	▲ (+/-)		●			
Q Σ • System reactive power	9	▲ (+/-)	▼	●	●	●	
PF1 • Phase 1 power factor	10	▲ (+/-)		●			●
PF2 • Phase 2 power factor	10	▲ (+/-)		●			
PF3 • Phase 3 power factor	10	▲ (+/-)		●			
PF Σ • System power factor	12	▲ (+/-)		●	●	●	
DPF1 • Phase 1 DPF	13			●			●
DPF2 • Phase 2 DPF	13			●			
DPF3 • Phase 3 DPF	13			●			
TAN \emptyset 1 • Phase 1 tangent \emptyset	11	▲ (+/-)		●			●
TAN \emptyset 2 • Phase 2 tangent \emptyset	11	▲ (+/-)		●			
TAN \emptyset 3 • Phase 3 tangent \emptyset	11	▲ (+/-)		●			
TAN $\emptyset\Sigma$ • System tangent \emptyset	12	▲ (+/-)		●	●	●	
THDV1 • Phase 1-N voltage THD	14	▲		●			●
THDV2 • Phase 2-N voltage THD	14	▲		●			
THDV3 • Phase 3-N voltage THD	14	▲		●			
THDV12 • Line 12 voltage THD	15	▲		●	●	●	
THDV23 • Line 23 voltage THD	15	▲		●	●	●	
THDV31 • Line 31 voltage THD	15	▲		●	●	●	
THDA1 • Phase 1 current THD	16	▲		●	●	●	●
THDA2 • Phase 2 current THD	16	▲		●	●		
THDA3 • Phase 3 current THD	16	▲		●	●	●	
THDAN • Neutral current THD*	17	▲		●			
F • Frequency	4			●	●	●	●

■ Available only for ENH instrument version.

* The neutral current and the derivative parameters (AN, THDAN, HaAN) are not available if the set CT ratio or FSA value is different for each phase.

8.8 LOOP 2 - DMD VALUES

In this loop, the demand values (DMD) and the corresponding max values are displayed according to the instrument model and the set wiring mode. The demand values are calculated according to the set DMD mode and integration time (refer to section 8.15.12).

Scroll the loop pages with **▲** or **▼** button.

The following pages refer to the full optional instrument version with 3 phase, 4 wire, 3 current insertion.

➔

1		2		3	
4		5		6	
7		8		9	
10		11		12	
13		14		15	

8.9 DMD MAX VALUE

To show the maximum values of the displayed DMD parameters (except for power balance values), press **▲** and **◀** buttons simultaneously for at least 2 s. The "▲" symbol will start to blink and the maximum values will be displayed for about 6 s.

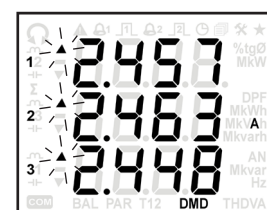

8.10 DMD PARAMETER TABLE

The following table shows the parameters available according to the instrument model and the set wiring mode. The column "DISPLAY PAGE" shows the number of the corresponding device page shown in section 8.8.

In 1 phase insertion, **BALANCE** values are resulting from the difference between the phase 1 imported power DMD and the phase 1 exported power DMD ($L1_{imp} - L1_{exp}$).

PARAMETER	DISPLAY PAGE	MAX (▲) VALUE	WIRING MODES (●=available)			
			3ph, 4w, 3c	3ph, 3w, 3c	3ph, 3w, 2c	1phase
$A1_{DMD}$ • Phase 1 current DMD	1	▲	●	●	●	●
$A2_{DMD}$ • Phase 2 current DMD	1	▲	●	●	●	
$A3_{DMD}$ • Phase 3 current DMD	1	▲	●	●	●	
AN_{DMD} • Neutral current DMD*	2	▲	●			
$A\sum_{DMD}$ • System current DMD	2	▲	●	●	●	
$+P1_{DMD}$ • Phase 1 imported active power DMD	3	▲	●			●
$-P1_{DMD}$ • Phase 1 exported active power DMD	4	▲	●			●
$+P2_{DMD}$ • Phase 2 imported active power DMD	3	▲	●			
$-P2_{DMD}$ • Phase 2 exported active power DMD	4	▲	●			
$+P3_{DMD}$ • Phase 3 imported active power DMD	3	▲	●			
$-P3_{DMD}$ • Phase 3 exported active power DMD	4	▲	●			
$+P\sum_{DMD}$ • System imported active power DMD	9	▲	●	●	●	
$-P\sum_{DMD}$ • System exported active power DMD	10	▲	●	●	●	
$P\sum_{DMD}BAL$ • Balance of system active power DMD (imp-exp)	11		●	●	●	●
$+S1_{DMD}$ • Phase 1 imported apparent power DMD	5	▲	●			●
$-S1_{DMD}$ • Phase 1 exported apparent power DMD	6	▲	●			●
$+S2_{DMD}$ • Phase 2 imported apparent power DMD	5	▲	●			
$-S2_{DMD}$ • Phase 2 exported apparent power DMD	6	▲	●			
$+S3_{DMD}$ • Phase 3 imported apparent power DMD	5	▲	●			
$-S3_{DMD}$ • Phase 3 exported apparent power DMD	6	▲	●			
$+S\sum_{DMD}$ • System imported apparent power DMD	9	▲	●	●	●	
$-S\sum_{DMD}$ • System exported apparent power DMD	10	▲	●	●	●	
$S\sum_{DMD}BAL$ • Balance of system apparent power DMD (imp-exp)	11		●	●	●	●
$+Q1_{DMD}$ • Phase 1 imported reactive power DMD	7	▲	●			●
$-Q1_{DMD}$ • Phase 1 exported reactive power DMD	8	▲	●			●
$+Q2_{DMD}$ • Phase 2 imported reactive power DMD	7	▲	●			
$-Q2_{DMD}$ • Phase 2 exported reactive power DMD	8	▲	●			
$+Q3_{DMD}$ • Phase 3 imported reactive power DMD	7	▲	●			
$-Q3_{DMD}$ • Phase 3 exported reactive power DMD	8	▲	●			
$+Q\sum_{DMD}$ • System imported reactive power DMD	9	▲	●	●	●	
$-Q\sum_{DMD}$ • System exported reactive power DMD	10	▲	●	●	●	
$Q\sum_{DMD}BAL$ • Balance of system reactive power DMD (imp-exp)	11		●	●	●	●
$+PF1_{DMD}$ • Phase 1 inductive power factor DMD	12	▲	●			●
$-PF1_{DMD}$ • Phase 1 capacitive power factor DMD	13	▲	●			●
$+PF2_{DMD}$ • Phase 2 inductive power factor DMD	12	▲	●			
$-PF2_{DMD}$ • Phase 2 capacitive power factor DMD	13	▲	●			
$+PF3_{DMD}$ • Phase 3 inductive power factor DMD	12	▲	●			
$-PF3_{DMD}$ • Phase 3 capacitive power factor DMD	13	▲	●			
$+PF\sum_{DMD}$ • System inductive power factor DMD	14	▲	●	●	●	
$-PF\sum_{DMD}$ • System capacitive power factor DMD	15	▲	●	●	●	

■ Available only for ENH instrument version.

* The neutral current and the derivative parameters (AN, THDAN, HaAN) are not available if the set CT ratio or FSA value is different for each phase.

8.11 LOOP 3 - HARMONIC VALUES

Harmonics up to 15th order are displayed in absolute value according to the set wiring mode.

The harmonics are calculated each 7 s. With \uparrow or \downarrow button, scroll the pages in the harmonic component group.

To go to the next harmonic component group (e.g. haV1 \rightarrow haV2), press \uparrow and \leftarrow buttons simultaneously.

To go to the previous harmonic component group (e.g. haV1 \rightarrow haAN), press \downarrow and \leftarrow buttons simultaneously.

The following pages refer to the full optional instrument version with 3 phase, 4 wire, 3 current insertion.



NOTE. The harmonic pages can display “_ _ _ _” instead of values, when the voltage or current RMS values are lower than the threshold values defined for FFT calculation (refer to chapter 9).

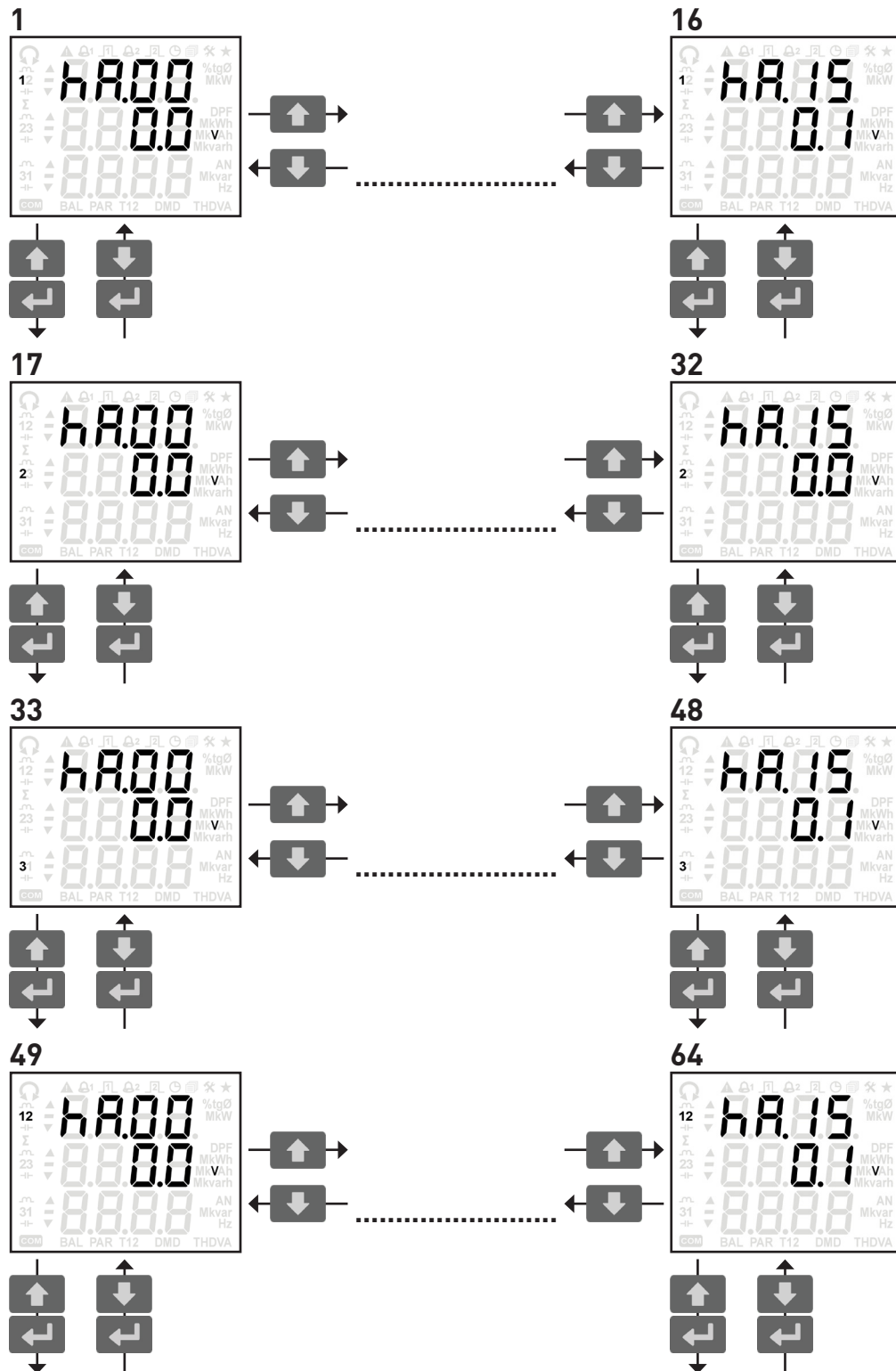

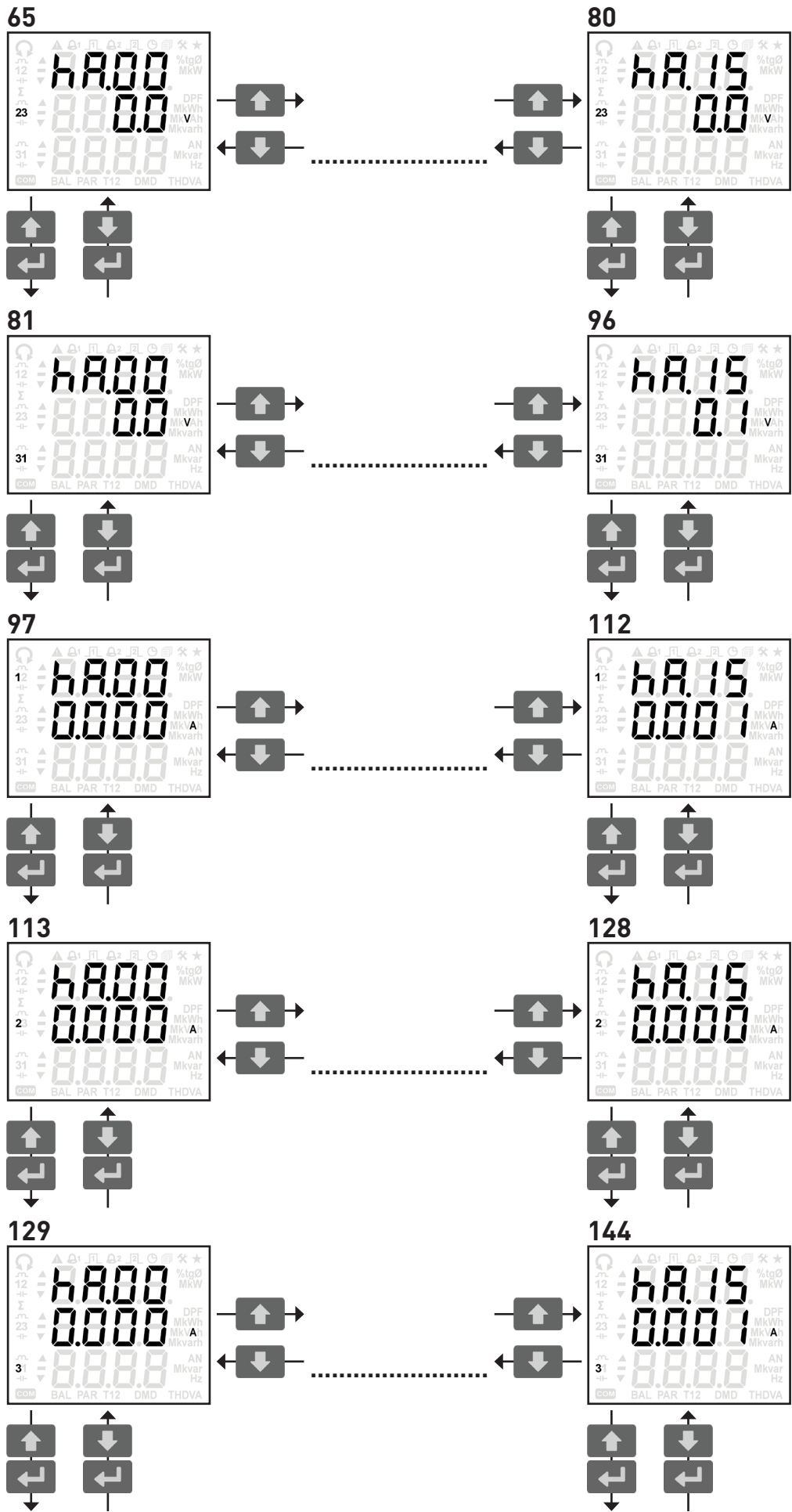

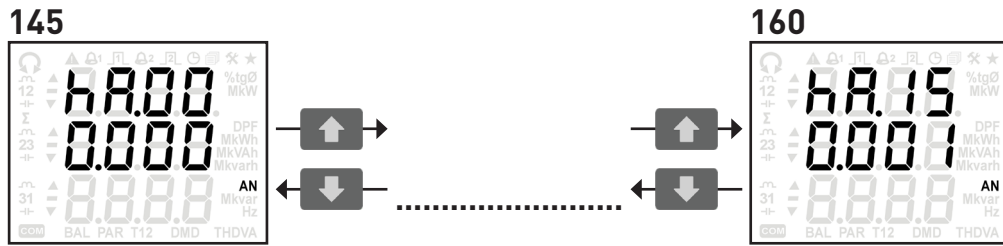

8.12 HARMONIC PARAMETER TABLE

The following table shows the parameters available according to the instrument model and the set wiring mode. The column "DISPLAY PAGE RANGE" shows the corresponding device page range shown in section 8.11.

PARAMETER	DISPLAY PAGE RANGE	WIRING MODES (●=available)			
		3ph, 4w, 3c	3ph, 3w, 3c	3ph, 3w, 2c	1phase
HaV1 • Phase 1-N voltage harmonic component 0 (DC)...15 th	1...16	●			●
HaV2 • Phase 2-N voltage harmonic component 0 (DC)...15 th	17...32	●			
HaV3 • Phase 3-N voltage harmonic component 0 (DC)...15 th	33...48	●			
HaV12 • Line 12 voltage harmonic component 0 (DC)...15 th	49...64	●	●	●	
HaV23 • Line 23 voltage harmonic component 0 (DC)...15 th	65...80	●	●	●	
HaV31 • Line 31 voltage harmonic component 0 (DC)...15 th	81...96	●	●	●	
HaA1 • Phase 1 current harmonic component 0 (DC)...15 th	97...112	●	●	●	●
HaA2 • Phase 2 current harmonic component 0 (DC)...15 th	113...128	●	●		
HaA3 • Phase 3 current harmonic component 0 (DC)...15 th	129...144	●	●	●	
HaAN • Neutral current harmonic component 0 (DC)...15 th *	145...160	●			

■ Available only for ENH instrument version.

* The neutral current and the derivative parameters (AN, THDAN, HaAN) are not available if the set CT ratio or FSA value is different for each phase.

8.13 LOOP 4 - ENERGY COUNTERS

In this loop, the energy counters are displayed according to the instrument model and the set wiring mode. Apparent energy can be shown as total counters (ind+cap) or with separated inductive and capacitive values depending on the instrument configuration. Scroll the loop pages with **▲** or **▼** button.

The following pages refer to the full optional instrument version provided with Total apparent counters (ind+cap) option and with 3 phase, 4 wire, 3 current insertion.

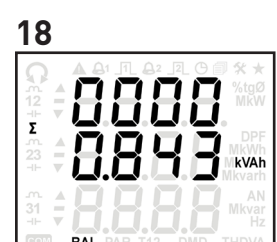
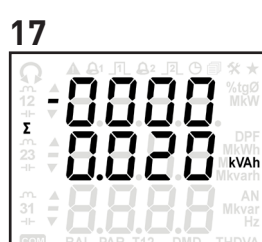
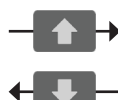
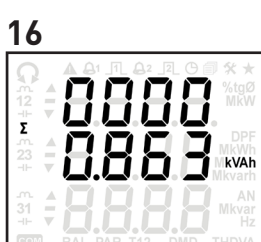
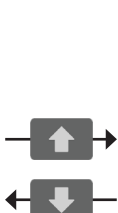
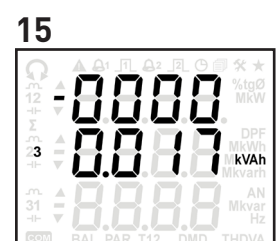
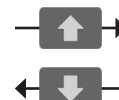
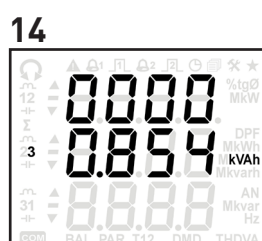
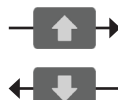
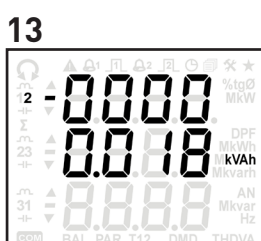
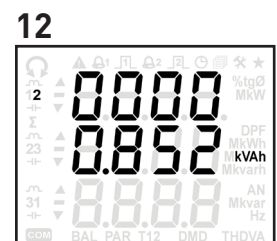
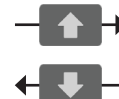
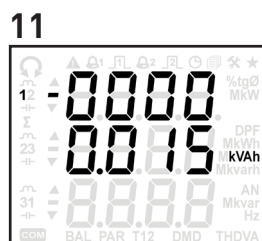
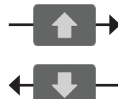
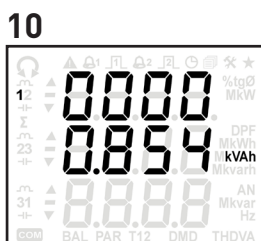
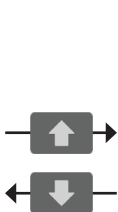
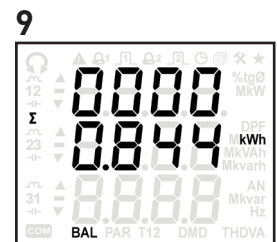
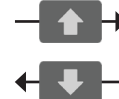
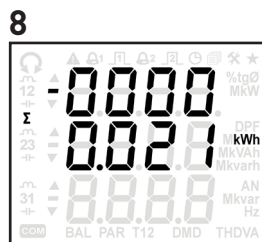
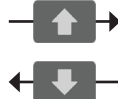
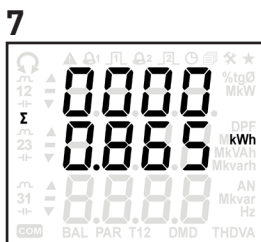
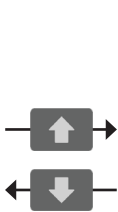
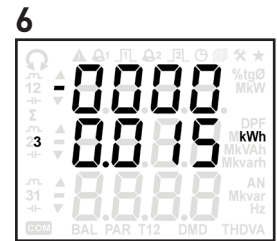
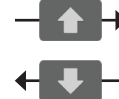
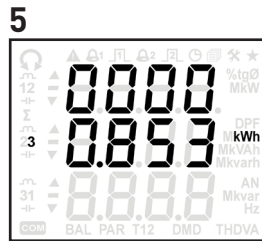
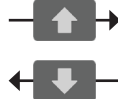
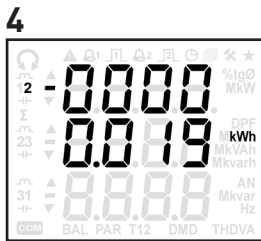
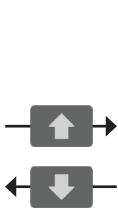
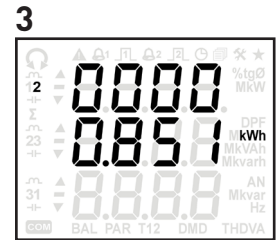
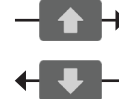
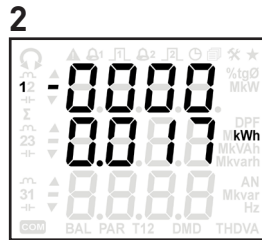
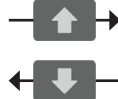
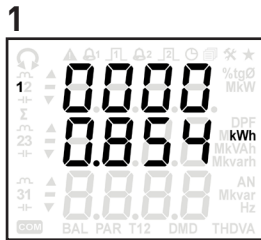

19

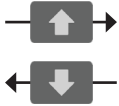
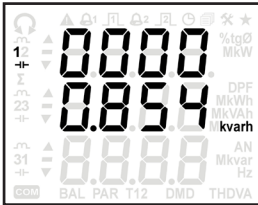
20



21

22

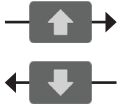
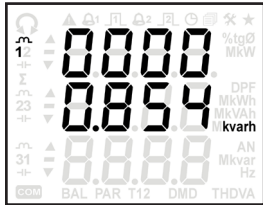
23

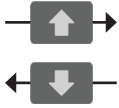
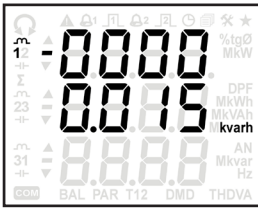

24

25

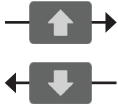
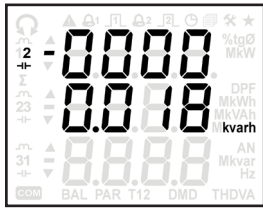
26

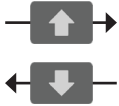
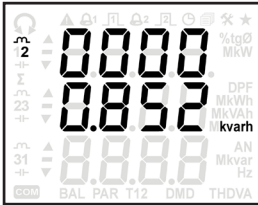

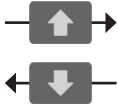
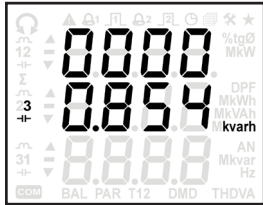

27

28

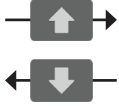
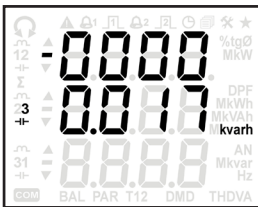
29

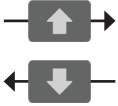
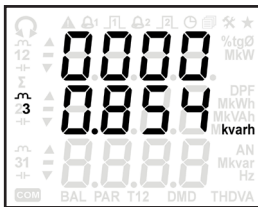

30

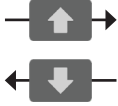
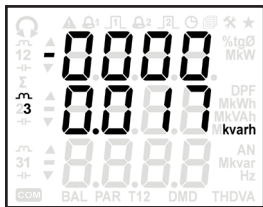

31

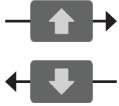
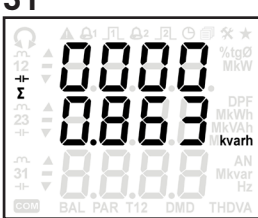
32

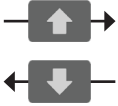
33

34

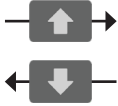
35

36

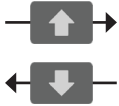
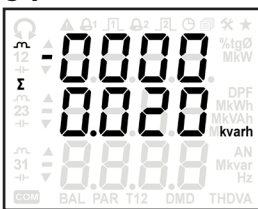
37

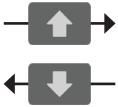
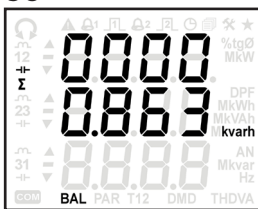
8.14 ENERGY COUNTER TABLE

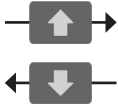
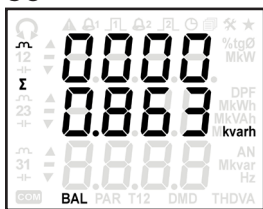
The following table shows the parameters available according to the instrument model and the set wiring mode. The column "DISPLAY PAGE" shows the number of the corresponding device page shown in section 8.13.

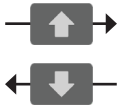
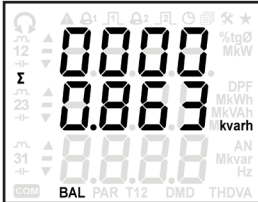
In 1 phase insertion, **BALANCE** values are resulting from the difference between the phase 1 imported energy and the phase 1 exported energy ($L1_{imp} - L1_{exp}$).

PARAMETER	DISPLAY PAGE	WIRING MODES (●=available)			
		3ph, 4w, 3c	3ph, 3w, 3c	3ph, 3w, 2c	1phase
+kWh1 • Phase 1 imported active energy	1	●			●
-kWh1 • Phase 1 exported active energy	2	●			●
+kWh2 • Phase 2 imported active energy	3	●			
-kWh2 • Phase 2 exported active energy	4	●			
+kWh3 • Phase 3 imported active energy	5	●			
-kWh3 • Phase 3 exported active energy	6	●			
+kWhΣ • System imported active energy	7	●	●	●	
-kWhΣ • System exported active energy	8	●	●	●	
kWhΣBAL • Balance of system active energy (imp-exp)	9	●	●	●	●
+kVAh1-C • Phase 1 imported capacitive apparent energy		●			●
-kVAh1-C • Phase 1 exported capacitive apparent energy		●			●
+kVAh1-L • Phase 1 imported inductive apparent energy		●			●
-kVAh1-L • Phase 1 exported inductive apparent energy		●			●
+kVAh1 • Phase 1 imported apparent energy	10	●			●
-kVAh1 • Phase 1 exported apparent energy	11	●			●
+kVAh2-C • Phase 2 imported capacitive apparent energy		●			
-kVAh2-C • Phase 2 exported capacitive apparent energy		●			
+kVAh2-L • Phase 2 imported inductive apparent energy		●			
-kVAh2-L • Phase 2 exported inductive apparent energy		●			
+kVAh2 • Phase 2 imported apparent energy	12	●			
-kVAh2 • Phase 2 exported apparent energy	13	●			
+kVAh3-C • Phase 3 imported capacitive apparent energy		●			
-kVAh3-C • Phase 3 exported capacitive apparent energy		●			
+kVAh3-L • Phase 3 imported inductive apparent energy		●			
-kVAh3-L • Phase 3 exported inductive apparent energy		●			
+kVAh3 • Phase 3 imported apparent energy	14	●			
-kVAh3 • Phase 3 exported apparent energy	15	●			
+kVAhΣ-C • System imported capacitive apparent energy		●	●	●	
-kVAhΣ-C • System exported capacitive apparent energy		●	●	●	
+kVAhΣ-L • System imported inductive apparent energy		●	●	●	
-kVAhΣ-L • System exported inductive apparent energy		●	●	●	
+kVAhΣ • System imported apparent energy	16	●	●	●	
-kVAhΣ • System exported apparent energy	17	●	●	●	
kVAhΣBAL-C • Balance of system capacitive apparent en. (imp-exp)		●	●	●	●
kVAhΣBAL-L • Balance of system inductive apparent en. (imp-exp)		●	●	●	●
kVAhΣBAL • Balance of system apparent energy (imp-exp) [BAL-C + BAL-L]	18	●	●	●	●
+kvarh1-C • Phase 1 imported capacitive reactive energy	19	●			●
-kvarh1-C • Phase 1 exported capacitive reactive energy	20	●			●
+kvarh1-L • Phase 1 imported inductive reactive energy	21	●			●
-kvarh1-L • Phase 1 exported inductive reactive energy	22	●			●

■ Available only for instrument with separated Inductive and Capacitive apparent counters.

■ Available only for instrument with Total apparent counters (ind+cap).

PARAMETER	DISPLAY PAGE	WIRING MODES (●=available)			
		3ph, 4w, 3c	3ph, 3w, 3c	3ph, 3w, 2c	1phase
+kvarh2-C • Phase 2 imported capacitive reactive energy	23	●			
-kvarh2-C • Phase 2 exported capacitive reactive energy	24	●			
+kvarh2-L • Phase 2 imported inductive reactive energy	25	●			
-kvarh2-L • Phase 2 exported inductive reactive energy	26	●			
+kvarh3-C • Phase 3 imported capacitive reactive energy	27	●			
-kvarh3-C • Phase 3 exported capacitive reactive energy	28	●			
+kvarh3-L • Phase 3 imported inductive reactive energy	29	●			
-kvarh3-L • Phase 3 exported inductive reactive energy	30	●			
+kvarh Σ -C • System imported capacitive reactive energy	31	●	●	●	
-kvarh Σ -C • System exported capacitive reactive energy	32	●	●	●	
+kvarh Σ -L • System imported inductive reactive energy	33	●	●	●	
-kvarh Σ -L • System exported inductive reactive energy	34	●	●	●	
kvarh Σ BAL-C • Balance of system capacitive reactive en. (imp-exp)	35	●	●	●	●
kvarh Σ BAL-L • Balance of system inductive reactive en. (imp-exp)	36	●	●	●	●
kvarh Σ BAL • Balance of system reactive energy (imp-exp) [BAL-C + BAL-L]	37	●	●	●	●

8.15 LOOP 5 - SETUP

In this loop, pages for instrument setup are displayed according to the instrument model.

To access Setup loop, on **Setup?** page press button and then insert the requested password as following described (default value: 0000):

1. Press , the first value digit will start to blink.
2. Change the value with or and confirm with .
3. Proceed in the same way for the following digits.

The first Setup page (Wiring mode) will be displayed. Scroll the loop pages with or button.



NOTE. In case of password forgotten, access the Setup loop by inserting the last four digits of the instrument serial number (e.g. if instrument serial number=J142P90001, recovery password=0001).

To exit from Setup loop, press for at least 3 s. A new page will be displayed to save the settings. With or button select the blinking item:

- **YES**=exit and save the settings
- **NO**=exit without saving the settings
- **CONT**=continue to scroll Setup pages

Confirm with button. Selecting **YES** or **NO**, the first Info page (instrument firmware release) will be displayed. Selecting **CONT**, the last Setup page will be displayed.

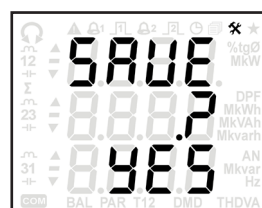
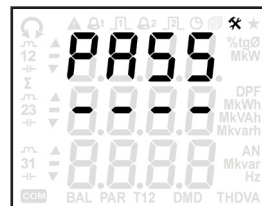

8.15.1 Wiring mode selection



WARNING! If the wiring mode is modified, the instrument will:

- **reset all MIN/MAX values, all DMD values, all energy counters**
- **set digital outputs to the default settings (disabled)**
- **set the default recording setup (disabled) and delete all recorded data**

By this page, it is possible to select the wiring mode, according to the real instrument connection. Available wiring modes:

- **3.4.3:** 3 phases 4 wires 3 currents
- **3.3.3:** 3 phases 3 wires 3 currents
- **3.3.2:** 3 phases 3 wires 2 currents
- **1Ph:** 1 phase

To change the wiring mode, press button, the corresponding item will start to blink. With or button select the mode and confirm with button.



8.15.2 CT setup mode

This page is available only for 1/5A CT instrument.



WARNING! If the CT setup mode is modified, the instrument will:

- **reset all MIN/MAX values, all DMD values, all energy counters**
- **set digital outputs to the default settings (disabled)**
- **set the default recording setup (disabled) and delete all recorded data**

By this page, CT setup mode can be selected between:

- **ALL:** a single CT ratio common for all phases.
- **SEP:** CT ratio separated for each phase (1, 2, 3).

To change the mode, press button, the corresponding item will start to blink. With or button select the mode and confirm with button.



8.15.3 CT ratio setup

These pages are available only for 1/5A CT instrument.



WARNING! If the CT ratio is modified, the instrument will:

- reset all MIN/MAX values, all DMD values, all energy counters
- set digital outputs to the default settings (disabled)
- set the default recording setup (disabled) and delete all recorded data



WARNING! The CT ratio depends on the PT ratio. If the CT*PT product is too high, an error symbol starts to blink on the display and the CT ratio must be set again. The CT or PT ratio must be set considering the following formula: CT primary * PT primary * 3 < 9999 MW

The pages for CT primary and secondary setup can be different according to the selection made for CT setup mode (ALL or SEP). Refer to the following description.

In case of "ALL" CT setup mode

1. To change the CT primary, press button, the first digit will start to blink. With or button select the digit and confirm with button. Repeat the same procedure for the other digits. At the end, press button to confirm the whole value. Value range: 0.001...50.000 kA.
2. After CT primary setup, press button to go to the CT secondary page.
3. To change the CT secondary, press button, the value will start to blink. With or button select the value and confirm with button. Selectable values: 1, 5 A.

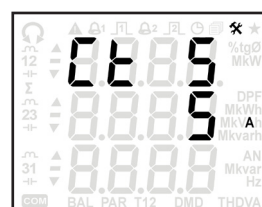

In case of "SEP" CT setup mode

1. To change the phase 1 CT primary, press button, the first digit will start to blink. With or button select the digit and confirm with button. Repeat the same procedure for the other digits. At the end, press button to confirm the whole value. Value range: 0.001...50.000 kA.
2. After phase 1 CT primary setup, press button to go to the phase 1 CT secondary page.
3. To change the phase 1 CT secondary, press button, the value will start to blink. With or button select the value and confirm with button. Selectable values: 1, 5 A.
4. After phase 1 CT secondary setup, press button to go to the phase 2 CT primary page. The phase index can be identified by the corresponding symbol shown on the display left side. To set CT ratio for phase 2 and 3, repeat the same procedure of points 1, 2, 3.

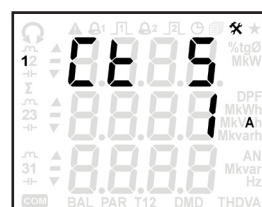
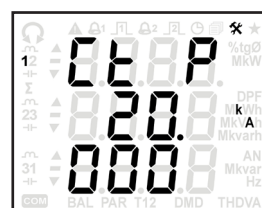

8.15.4 Current full scale (FSA) setup mode

This page is available only for instrument with Rogowski inputs.



WARNING! If the FSA setup mode is modified, the instrument will:

- reset all MIN/MAX values, all DMD values, all energy counters
- set digital outputs to the default settings (disabled)
- set the default recording setup (disabled) and delete all recorded data

By this page, current full scale setup mode can be selected between:

- **ALL**: a single current full scale common for all phases.
- **SEP**: current full scale separated for each phase (1, 2, 3).

To change the mode, press button, the corresponding item will start to blink. With or button select the mode and confirm with button.



8.15.5 Current full scale (FSA) setup

This page is available only for instrument with Rogowski inputs.

WARNING! If the current full scale (FSA) is modified, the instrument will:

- reset all MIN/MAX values, all DMD values, all energy counters
- set digital outputs to the default settings (disabled)
- set the default recording setup (disabled) and delete all recorded data

WARNING! The current full scale value (FSA) depends on the PT ratio. If the $FSA \cdot PT$ product is too high, an error symbol starts to blink on the display and the FSA must be set again. The FSA must be set considering the following formula:
 $FSA \cdot PT \text{ primary} \cdot 3 < 9999 \text{ MW}$

The current full scale page can be different according to the selection made for FSA setup mode (ALL or SEP). Refer to the following description.

In case of "ALL" FSA setup mode

1. To change the full scale, press \leftarrow button, the value will start to blink. With \uparrow or \downarrow button select the value and confirm with \leftarrow button. Selectable values: 500A / 4kA / 20kA.

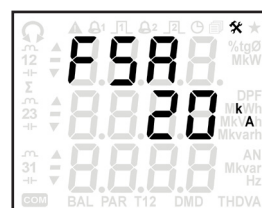

In case of "SEP" FSA setup mode

1. To change the phase 1 full scale, press \leftarrow button, the value will start to blink. With \uparrow or \downarrow button select the value and confirm with \leftarrow button. Selectable values: 500A / 4kA / 20kA.
2. After phase 1 full scale setup, press \uparrow button to go to the phase 2 full scale page. The phase index can be identified by the corresponding symbol shown on the display left side. To set current full scale for phase 2 and 3, repeat the same procedure of points 1 and 2.



8.15.6 PT ratio setup

WARNING! If the PT ratio is modified, the instrument will:

- reset all MIN/MAX values, all DMD values, all energy counters
- set digital outputs to the default settings (disabled)
- set the default recording setup (disabled) and delete all recorded data

WARNING! The PT ratio depends on the CT ratio (1/5A CT model) or on the FSA (Rogowski model). If the $CT \cdot PT$ or $FSA \cdot PT$ product is too high, an error symbol starts to blink on the display and the PT ratio must be set again. The PT ratio must be set considering the following formula: $CT \text{ primary}$ or $FSA \cdot PT \text{ primary} \cdot 3 < 9999 \text{ MW}$

The pages for PT primary and secondary setup are common for all phases. To set PT primary and secondary values, refer to the following description.

1. To change the PT primary, press \leftarrow button, the first digit will start to blink. With \uparrow or \downarrow button select the digit and confirm with M/\rightarrow button. Repeat the same procedure for the other digits. At the end, press \leftarrow button to confirm the whole value. Value range: 0.001...999.999 kV. For direct connection set 1, PT secondary will be automatically set to 1 too.
2. After PT primary setup, press \uparrow button to go to the PT secondary page.
3. To change the PT secondary, press \leftarrow button, the value will start to blink. With \uparrow or \downarrow button select the value and confirm with M/\rightarrow button. Repeat the same procedure for the other digits. At the end, press \leftarrow button to confirm the whole value. Value range: 80...150 V. If PT primary was set to 1, PT secondary is automatically fixed to 1 and it is not programmable.



8.15.7 Communication speed selection

This page is available only for instrument with RS485 port.

By this page, it is possible to select the communication speed. Selectable values: 300, 600, 1.2k, 2.4k, 4.8k, 9.6k, 19.2k, 38.4k, 57.6k bps. Example: 19.2k=19200 bps

To change the value, press **←** button, the corresponding item will start to blink. With **↑** or **↓** button select the communication speed and confirm with **←** button.



8.15.8 MODBUS address setup

This page is available only for instrument with RS485 port.

By this page, it is possible to set the MODBUS address in decimal format. Value range: 1...247

To change the value, press **←** button, the first digit will start to blink. With **↑** or **↓** button select the digit and confirm with **M/▶** button. Repeat the same procedure for the other digits. At the end, press **←** button to confirm the whole value.



8.15.9 ETHERNET set default

This page is available only for instrument with ETHERNET port.

By this page, it is possible to restore to the default values the following ETHERNET settings: IP address, account access in web server. Default values:

- **IP address:** 192.168.1.249
- **Admin username:** admin
- **Admin password:** admin

To perform ETHERNET set default, press **←** button, a confirmation page (**CONF?**) will be displayed. With **↑** or **↓** button select the blinking item:

- **YES**=ETHERNET set default.
- **NO**=no set default is performed

Confirm with **←** button. The last displayed page will be shown.

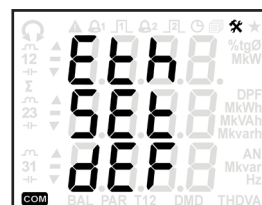

8.15.10 Digital output settings (DO)

By these pages, it is possible to enable/disable two digital outputs (DO) for threshold alarm or energy pulse emission.

At first User setup access, the digital outputs are disabled (NONE) and no parameter is associated. To enable the digital output 1, press **←** button, the NONE item will start to blink. With **▲** or **▼** button select the mode (**AL H**, **AL L**, **PULS**). Confirm with **←** button.

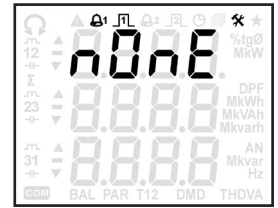

In case of ALARM MODE selection

In alarm mode, the digital output functionality can change according to the associated parameter. For further details, refer to the following table:

MODE	PARAMETER TO BE ASSOCIATED	FUNCTION DESCRIPTION
AL H	Real time values, DMD values	The output is activated (closed) when the associated parameter value is higher than the set threshold, considering also the set hysteresis.
	Active power sign	The output is activated (closed) when the active power* sign becomes negative, considering also the set delay.
AL L	Real time values, DMD values	The output is activated (closed) when the associated parameter value is lower than the set threshold, considering also the set hysteresis.
	Active power sign	The output is activated (closed) when the active power* sign becomes positive, considering also the set delay.

* Note. The active power parameter considered for sign changing depends on the set wiring:
3phase wiring=System active power, 1phase wiring=Phase 1 active power

- The symbols which identify the parameter type (e.g. A1=phase 1 current) will start to blink. With **▲** or **▼** button select the parameter to be associated to the digital output and confirm with **←** button. Selectable parameters: Real time values (refer to section 8.7), active power sign (SIGN) or DMD values (refer to section 8.10). The **Active power sign** parameter can be identified by **SIGN** displayed on the second row.
- In case of real time or DMD parameter selection**, the second row will display threshold value. After parameter selection, the threshold first digit will start to blink. With **▲** or **▼** button select the digit and confirm with **←** button. Repeat the same procedure for the other digits. The value range changes according to the selected parameter. **In case of Active power sign parameter selection**, the second row will display the SIGN static text instead of the threshold value.
- In case of real time or DMD parameter selection**, the third row will display hysteresis value. After threshold selection, the hysteresis first digit will start to blink. With **▲** or **▼** button select the digit and confirm with **←** button. Repeat the same procedure for the other digit. Value range: 0...50%. **In case of Active power sign parameter selection**, the third row will display the delay value. After parameter selection, the delay first digit will start to blink. With **▲** or **▼** button select the digit and confirm with **←** button. Repeat the same procedure for the other digit. Value range: 1...60s. By programming this value, the output is activated (closed) if the sign remains changed after the set delay. E.g. Digital output set as AL H SIGN with 10s delay: the output is activated (closed) if the sign changes from + to - and this condition lasts more than 10s. Then, if the sign returns to +, the output is disactivated (opened) immediately, delay has no effect in the returning to normal condition.

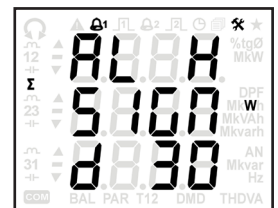

In case of PULSE MODE selection

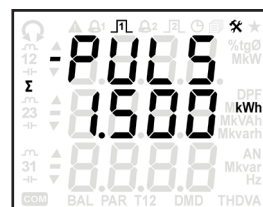

1. The symbols which identify the parameter type (e.g. -WhΣ=system exported active energy) will start to blink. With ▲ or ▼ button select the parameter to be associated to the digital output and confirm with ↵ button. Selectable parameters: Energy counters except balance values (refer to section 8.14).
2. The pulse value first digit will start to blink. With ▲ or ▼ button select the digit and confirm with ↵ button. Repeat the same procedure for the other digits. The value range changes according to the selected parameter.

For digital output 2 setup, refer to the digital output 1 description.

CONSIDERATIONS ON THE PULSE VALUE SETUP

Digital output can generate energy pulses with a maximum frequency of 8 pulse/s. The number of “pulses / kWh, kVAh, kvarh” must be set according to this condition to prevent overlapping. If higher number is set, overlap may occur.

Suppose maximum instant power:	$P_{max} = 5000 \text{ kW}$
Maximum energy / 1h:	5000000 Wh
Maximum pulse rate:	8 pulse/s = 8 x 3600 pulse/h = 28800 pulse/h
Maximum pulse weight:	$5000000/28800 = 173.6 \text{ Wh/pulse} \rightarrow 174 \text{ Wh/pulse}$

Similar calculation can be made for any type of energy. If pulse overlap condition occurs, the error situation is shown at display by a fast blinking of symbol JL, or it can be also identified in MODBUS protocol by reading the \$201C register.

8.15.11 Analog output settings (AO)

This page is available only for instrument with Analog output option.

By this page, it is possible to enable/disable an analog output (AO) for signal transmission to an external control device. At first Setup access, analog output is disabled (NONE) with no associated parameter. To enable the analog output, refer to the following description:

1. Press ↵ button, the NONE item will start to blink. With ▲ or ▼ button select the measuring range and confirm with M/▶ button. Selectable measuring ranges: 0-20, 4-20.
1. The symbols which identify the parameter type (e.g. VΣ=system voltage) will start to blink. With ▲ or ▼ button select the parameter to be associated to the analog output and confirm with M/▶ button. Selectable parameters: Real time values (refer to section 8.7).
2. The first digit of the low threshold will start to blink. With ▲ or ▼ button select the digit and confirm with M/▶ button. Repeat the same procedure for the other digits. The value range changes according to the selected parameter.
3. The first digit of the high threshold will start to blink. With ▲ or ▼ button select the digit and confirm with M/▶ button. Repeat the same procedure for the other digits. The value range changes according to the selected parameter.
4. At the end, press ↵ button to confirm the whole analog output setup.

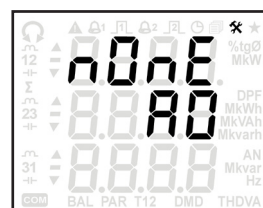

8.15.12 DMD calculation setup

⚠ WARNING! If the DMD mode or the integration time is modified, the instrument will reset the DMD & DMD MAX values and restart the DMD period.

The following DMD calculation modes are available according to the instrument model:

- **Fixed window (FIX):** the DMD value is updated only at the end of the DMD period.
- **Sliding window (SLID):** once the set DMD period is finished, the DMD value is updated after each minute.
- **Fixed with DI synchronisation (SYNC):** the DMD period synchronisation is made with a voltage pulse on the digital input.

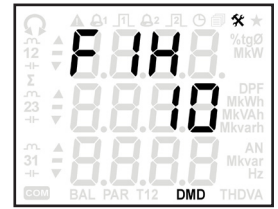

To select the DMD mode, press **←** button, the item on the first row will start to blink. With **↑** or **↓** button select the mode and confirm with **←** button.

The integration time will start to blink. With **↑** or **↓** button select the value and confirm with **←** button. Selectable values according to the DMD mode: 5, 10, 15, 30, 45, 60 minutes (45 and 60 values are not available in case of **Sliding window-SLID** selection).

CONSIDERATIONS ON THE DMD SYNCHRONISATION

As previously described, the DMD values can be calculated in 3 modes: fixed window period, sliding window period and synchronized by an external signal through digital input. In case of external synchronisation, DMD calculation is still with fixed window, and the main the period is defined still by the setup, e.g. 10 minutes. However, an external signal (pulse) will overwrite the period end if the difference between the sync signal moment and the period end is lower than 10 s. If not, the internal period timer + 10 s will end the integration period.

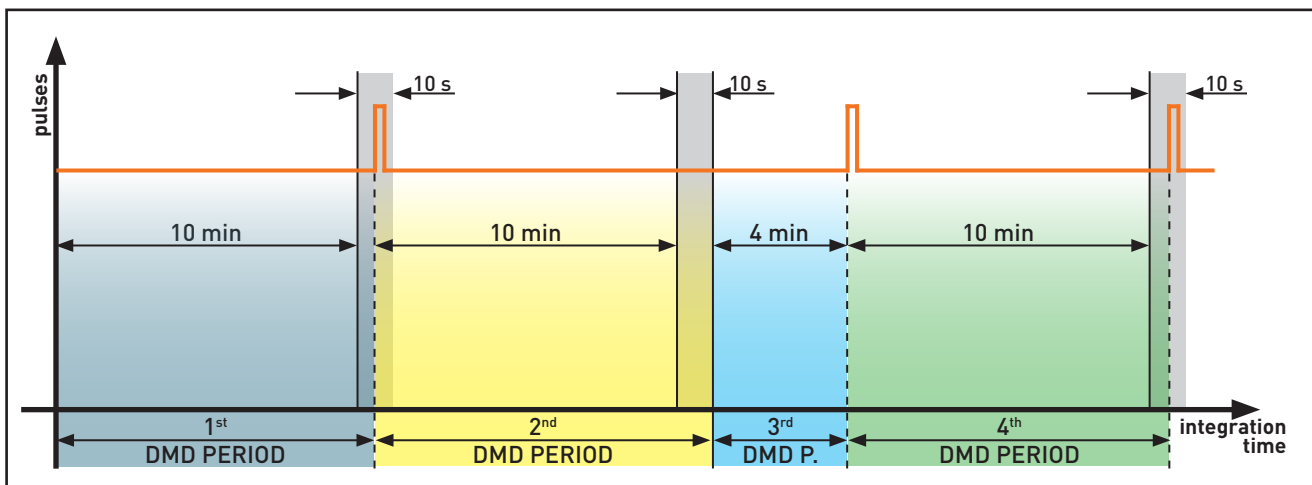

DMD synchronisation by pulses on digital input at 10 min. integration time

Suppose DMD period set to 10 minutes with external synchronisation.

If the external pulse is received after the 10 minute period, but before the 10 s delay, the DMD integration period is finished.

If the external pulse is not received after the 10 minute period and the 10 s delay, the DMD integration period is finished after the delay (DMD period length: 10 min+10 s).

If the pulse is received during the 10 minute period, e.g. after 4 minutes, the DMD integration period is finished.

8.15.13 Real time clock

By this page, it is possible to set date and time. Set always date & time before starting the data recording.

WARNING! Summer time (DST) is not managed automatically. In case of time changes, check and set again the clock.

WARNING! The instrument date&time could be lost in case of:

- instrument upgrade
- instrument switching off

In this cases, it is suggested to check and set again the instrument clock.

WARNING! If the date&time is lost or modified, the recording is automatically stopped. It is suggested to download the recorded data and set again date&time. Restart the recording by setting the rate, the old recorded data will be deleted.

The date and time are represented in the following format:

YYYY (year, e.g. 2014)

MM.DD (month and day, e.g. June 4th)

hh.mm (hours and minutes, e.g. 12:39)

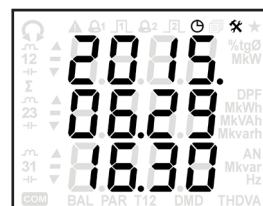

To set the date and time, press **←** button, the year first digit will start to blink. With **↑** or **↓** button select the digit and confirm with **M/→** button. Repeat the same procedure for the other digits. At the end, press **←** button to confirm the whole clock setup.

8.15.14 Energy counter reset

By this page, it is possible to reset an energy counter group. According to the displayed symbols, the energy counter group can be identified as follows:

- **kWh**: imported active energies (+kWh1, +kWh2, +kWh3, +kWhΣ)
- **-kWh**: exported active energies (-kWh1, -kWh2, -kWh3, -kWhΣ)
- **kVAh**: imported apparent energies (+kVAh1-L, +kVAh1-C, +kVAh2-L, +kVAh2-C, +kVAh3-L, +kVAh3-C, +kVAhΣ-L, +kVAhΣ-C)
- **-kVAh**: exported apparent energies (-kVAh1-L, -kVAh1-C, -kVAh2-L, -kVAh2-C, -kVAh3-L, -kVAh3-C, -kVAhΣ-L, -kVAhΣ-C)
- **kvarh**: imported reactive energies (+kvarh1-L, +kvarh1-C, +kvarh2-L, +kvarh2-C, +kvarh3-L, +kvarh3-C, +kvarhΣ-L, +kvarhΣ-C)
- **-kvarh**: exported reactive energies (-kvarh1-L, -kvarh1-C, -kvarh2-L, -kvarh2-C, -kvarh3-L, -kvarh3-C, -kvarhΣ-L, -kvarhΣ-C)

WARNING! This function will erase the selected counter group: the reset data will not be retrievable.

To reset an energy counter group, press **←** button, the symbols which identify the counter group (e.g. kWh=imported active energies) will start to blink. With **↑** or **↓** button select the counter group to be reset and confirm with **←** button.

A confirmation page (**CONF?**) will be displayed. With **↑** or **↓** button select the blinking item:

- **YES**=reset the selected counter group
- **NO**=no reset is performed

Confirm with **←** button. The last displayed page will be shown.

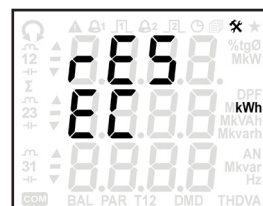





8.15.15 MAX value reset

By this page, it is possible to reset MAX values in groups. According to the displayed symbols, the MAX value group can be identified as follows:

- **Gr 1 (V)**: MAX voltages (V1, V2, V3, V12, V23, V31, VΣ)
- **Gr 2 (A)**: MAX currents (A1, A2, A3, AN, AΣ)
- **Gr 3 (kW)**: MAX imported active powers (+P1, +P2, +P3, +PΣ)
- **Gr 4 (-kW)**: MAX exported active powers (-P1, -P2, -P3, -PΣ)
- **Gr 5 (kVA)**: MAX imported apparent powers (+S1, +S2, +S3, +SΣ)
- **Gr 6 (-kVA)**: MAX exported apparent powers (-S1, -S2, -S3, -SΣ)
- **Gr 7 (kvar)**: MAX imported reactive powers (+Q1, +Q2, +Q3, +QΣ)
- **Gr 8 (-kvar)**: MAX exported reactive powers (-Q1, -Q2, -Q3, -QΣ)
- **Gr 9 (PF)**: MAX inductive power factors (+PF1, +PF2, +PF3, +PFΣ)
- **Gr 10 (-PF)**: MAX capacitive power factors (-PF1, -PF2, -PF3, -PFΣ)
- **Gr 11 (tg∅)**: MAX imported tangent ∅ (+TAN∅1, +TAN∅2, +TAN∅3, +TAN∅Σ)
- **Gr 12 (-tg∅)**: MAX exported tangent ∅ (-TAN∅1, -TAN∅2, -TAN∅3, -TAN∅Σ)
- **Gr 13 (THDV)**: MAX voltage THD (THDV1, THDV2, THDV3, THDV12, THDV23, THDV31, THDVΣ)
- **Gr 14 (THDA)**: MAX current THD (THDA1, THDA2, THDA3, THDAN)

 **WARNING! This function will erase the selected MAX value group: the reset data will not be retrievable.**

To reset a MAX value group, press  button, the symbols which identify the group (e.g. V=MAX voltages) will start to blink. With  or  button select the group to be reset and confirm with  button.

A confirmation page (**CONF?**) will be displayed. With  or  button select the blinking item:

- **YES**=reset the selected MAX value group
- **NO**=no reset is performed

Confirm with  button. The last displayed page will be shown.





8.15.16 DMD MAX value reset

By this page, it is possible to reset DMD MAX values in groups. According to the displayed symbols, the DMD MAX value group can be identified as follows:

- **Gr 1 (A)**: DMD MAX currents (A1, A2, A3, AΣ)
- **Gr 2 (kW)**: DMD MAX imported active powers (+P1, +P2, +P3, +PΣ)
- **Gr 3 (-kW)**: DMD MAX exported active powers (-P1, -P2, -P3, -PΣ)
- **Gr 4 (kVA)**: DMD MAX imported apparent powers (+S1, +S2, +S3, +SΣ)
- **Gr 5 (-kVA)**: DMD MAX exported apparent powers (-S1, -S2, -S3, -SΣ)
- **Gr 6 (kVA)**: DMD MAX imported reactive powers (+Q1, +Q2, +Q3, +QΣ)
- **Gr 7 (-kVA)**: DMD MAX exported reactive powers (-Q1, -Q2, -Q3, -QΣ)

 **WARNING! This function will erase the selected DMD MAX value group: the reset data will not be retrievable.**

To reset a DMD MAX value group, press  button, the symbols which identify the group (e.g. A=DMD MAX currents) will start to blink. With  or  button select the group to be reset and confirm with  button.



 Available only for ENH instrument version.

A confirmation page (**CONF?**) will be displayed. With **▲** or **▼** button select the blinking item:

- **YES**=reset the selected DMD MAX value group
- **NO**=no reset is performed

Confirm with **◀** button. The last displayed page will be shown.



8.15.17 MIN value reset

By this page, it is possible to reset MIN powers. According to the displayed symbols, the power type can be identified as follows:

- **kW**: MIN system active power [P_{Σ}]
- **kVA**: MIN system apparent power [S_{Σ}]
- **kvar**: MIN system reactive power [Q_{Σ}]

⚠ WARNING! This function will erase the selected MIN powers: the reset data will not be retrievable.

To reset MIN powers, press **◀** button, the symbols which identify the power type (e.g. kW=MIN system active power) will start to blink. With **▲** or **▼** button select the power type to be reset and confirm with **◀** button.



A confirmation page (**CONF?**) will be displayed. With **▲** or **▼** button select the blinking item:

- **YES**=reset the selected MIN powers
- **NO**=no reset is performed

Confirm with **◀** button. The last displayed page will be shown.



8.15.18 Data recording setup

⚠ WARNING! If the recording setup is modified, the recorded data will be deleted and it will not be retrievable.

⚠ WARNING! If the date&time is lost or modified, the recording is automatically stopped. It is suggested to download the recorded data and set again date&time. Restart the recording by setting the rate, the old recorded data will be deleted.

The data recording changes according to the instrument version:

- **Basic**: AVG active&reactive power recording
- **ENH**: MIN/AVG/MAX real time parameters recording (up to 24 parameters programmable) and energy counter recording

The following table shows the parameters automatically enabled for AVG recording in case of BASIC version, and the parameters which can be enabled (max 24) for MIN/AVG/MAX recording in case of ENH version. For both versions, the parameters are available according to the set wiring mode.

For the energy counter recording available only with ENH instrument version, the recorded parameters are the same described in section 8.14

PARAMETER	BASIC	ENH	WIRING MODES (●=available)			
			3ph, 4w, 3c	3ph, 3w, 3c	3ph, 3w, 2c	1phase
V1 • Phase 1-N voltage		■	●			●
V2 • Phase 2-N voltage		■	●			
V3 • Phase 3-N voltage		■	●			

PARAMETER	BASIC	ENH	WIRING MODES (●=available)			
			3ph, 4w, 3c	3ph, 3w, 3c	3ph, 3w, 2c	1phase
V12 • Line 12 voltage		■	●	●	●	
V23 • Line 23 voltage		■	●	●	●	
V31 • Line 31 voltage		■	●	●	●	
V_{Σ} • System voltage		■	●	●	●	
A1 • Phase 1 current		■	●	●	●	●
A2 • Phase 2 current		■	●	●	●	
A3 • Phase 3 current		■	●	●	●	
AN • Neutral current *		■	●			
A_{Σ} • System current		■	●	●	●	
P1 • Phase 1 active power (+/-)	■	■	●			●
P2 • Phase 2 active power (+/-)	■	■	●			
P3 • Phase 3 active power (+/-)	■	■	●			
P_{Σ} • System active power (+/-)	■	■	●	●	●	
S1 • Phase 1 apparent power		■	●			●
S2 • Phase 2 apparent power (+/-)		■	●			
S3 • Phase 3 apparent power (+/-)		■	●			
S_{Σ} • System apparent power (+/-)		■	●	●	●	
Q1 • Phase 1 reactive power (+/-)	■	■	●			●
Q2 • Phase 2 reactive power (+/-)	■	■	●			
Q3 • Phase 3 reactive power (+/-)	■	■	●			
Q_{Σ} • System reactive power (+/-)	■	■	●	●	●	
PF1 • Phase 1 power factor (+/-)		■	●			●
PF2 • Phase 2 power factor (+/-)		■	●			
PF3 • Phase 3 power factor (+/-)		■	●			
PF_{Σ} • System power factor (+/-)		■	●	●	●	
DPF1 • Phase 1 DPF		■	●			●
DPF2 • Phase 2 DPF		■	●			
DPF3 • Phase 3 DPF		■	●			
TANØ1 • Phase 1 tangent Ø (+/-)		■	●			●
TANØ2 • Phase 2 tangent Ø (+/-)		■	●			
TANØ3 • Phase 3 tangent Ø (+/-)		■	●			
$TANØ_{\Sigma}$ • System tangent Ø (+/-)		■	●	●	●	
THDV1 • Phase 1-N voltage THD		■	●			●
THDV2 • Phase 2-N voltage THD		■	●			
THDV3 • Phase 3-N voltage THD		■	●			
THDV12 • Line 12 voltage THD		■	●	●	●	
THDV23 • Line 23 voltage THD		■	●	●	●	
THDV31 • Line 31 voltage THD		■	●	●	●	
THDA1 • Phase 1 current THD		■	●	●	●	●
THDA2 • Phase 2 current THD		■	●	●		
THDA3 • Phase 3 current THD		■	●	●	●	
THDAN • Neutral current THD*		■	●			
F • Frequency		■	●	●	●	●
HaV1 • Phase 1-N voltage harmonic component 0 (DC)...15 th		■	●			●
HaV2 • Phase 2-N voltage harmonic component 0 (DC)...15 th		■	●			
HaV3 • Phase 3-N voltage harmonic component 0 (DC)...15 th		■	●			
HaV12 • Line 12 voltage harmonic component 0 (DC)...15 th		■	●	●	●	

* The neutral current and the derivative parameters (AN, THDAN, HaAN) are not available if the set CT ratio or FSA value is different for each phase.

PARAMETER	BASIC	ENH	WIRING MODES (●=available)			
			3ph, 4w, 3c	3ph, 3w, 3c	3ph, 3w, 2c	1phase
HaV23 • Line 23 voltage harmonic component 0 (DC)...15 th		■	●	●	●	
HaV31 • Line 31 voltage harmonic component 0 (DC)...15 th		■	●	●	●	
HaA1 • Phase 1 current harmonic component 0 (DC)...15 th		■	●	●	●	●
HaA2 • Phase 2 current harmonic component 0 (DC)...15 th		■	●	●		
HaA3 • Phase 3 current harmonic component 0 (DC)...15 th		■	●	●	●	
HaAN • Neutral current harmonic component 0 (DC)...15 th *		■	●			



NOTE. For PF parameters, the sign (+/-) means +=inductive value, -=capacitive value. For the other parameters, it means +=imported value, -=exported value.

According to the instrument version, refer to the following description.

BASIC instrument version

- To change the recording setup, press **←** button. The item on the second row (En or dIS) will start to blink. With **↑** or **↓** button select **En** to enable the recording, **dIS** to disable it. Confirm with **M/▶** button.
- After enabling/disabling, the recording rate will start to blink. With **↑** or **↓** button select the rate and confirm with **M/▶** button. Selectable values: 0 (disable), 1, 5, 10, 15, 30, 45, 60 minutes.
- After rate selection, the recording mode will start to blink (F or r). With **↑** or **↓** button select the mode and confirm with **M/▶** button. Selectable modes:
 - F**=FILL mode; the instrument records data up to filling the available space, when the space is filled in, any recording is stopped.
 - r**=RING mode; the instrument records data continuously. When the memory space is filled in, the oldest data is overwritten by the new data.
- At the end, press **←** button to confirm the whole recording setup.



ENH instrument version

- To change the recording setup, press **←** button. The recording mode will start to blink (F or r). With **↑** or **↓** button select the mode and confirm with **M/▶** button. Selectable modes:
 - F**=FILL mode; the instrument records data up to filling the available space. When the space is filled in, any recording is stopped.
 - r**=RING mode; the instrument records data continuously. When the memory space is filled in, the oldest data is overwritten by the new data.
- The position number on the second row will start to blink. Up to 24 parameters can be set for the recording. The blinking item **01** identifies the first position. With **↑** or **↓** button select the position number (1...24) and confirm with **M/▶** button. The symbols which identifies the real time parameter will start to blink (e.g. V1=phase 1-N voltage). With **↑** or **↓** button select the parameter to be associated to the position number and confirm with **M/▶** button. In case of harmonic parameter, the order number is displayed next to the position number (1...15). In case of symbol "-", no parameter is enabled for the corresponding position number (e.g. with V1 associated to position 01 and "-" to position 24, the V1 values will be recorded in position 1 but no value will be recorded in position 24).
- After parameter selection, the recording rate will start to blink. With **↑** or **↓** button select the rate and confirm with **M/▶** button. Selectable values in 10 s step: 0 (disable), 10...3600 s.
- At the end, press **←** button to confirm the whole recording setup.

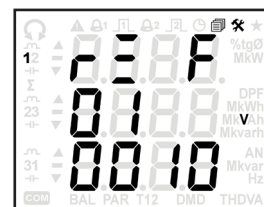

* The neutral current and the derivative parameters (AN, THDAN, HaAN) are not available if the set CT ratio or FSA value is different for each phase.

DETAIL ON MIN/AVG/MAX VALUE CALCULATION FOR RECORDING

Since the instrument is a 4 quadrant measurement device, all power, PF, TANØ parameters has a sign and can be positive or negative according to the actual quadrant.

The recording rate is programmable in 10 s step, between 10 and 3600 s. The recording rate corresponds also with the MIN/MAX values monitoring and AVG calculation period. The rate is synchronised with the internal realtime clock (RTC).

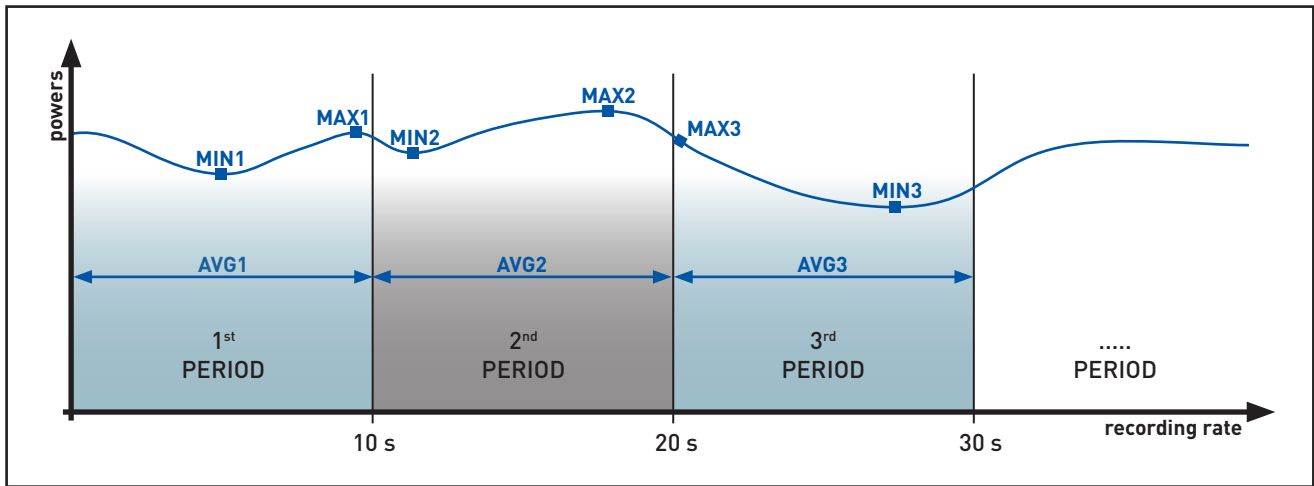

MIN/AVG/MAX recording at 10 s rate

Suppose that the recording rate is set to 10 s. Each RTC 10 s (e.g. hh:mm:00, hh:mm:10, hh:mm:20, hh:mm:30, hh:mm:40, hh:mm:50) three values for each enabled parameter are recorded:

- MIN value → the lowest value captured in the past 10 s period
- MAX value → the highest value captured in the past 10 s period
- AVG value → the arithmetical average calculated on all power values in the past 10 s period

The realtime monitoring rate is always 1 s. In the previous example 600 values was monitored for MIN and MAX values (10 * 60 s), and the AVG was calculated on the same 600 values. The recording is made at the end of each period with timestamp.

The recorded AVG values are not synchronised with the displayed realtime DMD values, both have separate integration period, with separate calculation.

The next page shows the energy counter recording setup (only for ENH instrument model). By this page, it is possible to enable data recording for all energy counters, according to the instrument model (refer to section 8.14). To change the recording setup:

1. Press **←** button. The item on the second row (En or dIS) will start to blink. With **↑** or **↓** button select **En** to enable the recording, **dIS** to disable it. Confirm with **M/▶** button.
2. After enabling/disabling, the recording rate will start to blink. With **↑** or **↓** button select the rate and confirm with **←** button. Selectable values: 0 (disable), 1...60 minutes.

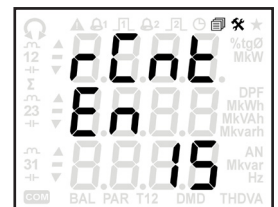

8.15.19 Data recording erase

⚠ WARNING! This function will erase all recorded data without change recording setup: the deleted data will not be retrievable.

The data recording deletion changes according to the instrument version:

- **Basic:** delete AVG active&reactive recording
- **ENH:** delete MIN/AVG/MAX, energy counter recording or both

BASIC instrument version

To delete all recorded data, press **←** button, a confirmation page (**CONF?**) will be displayed. With **↑** or **↓** button select the blinking item:

- **YES**=delete all recorded data.
- **NO**=no deletion is performed

Confirm with **←** button. The last displayed page will be shown.

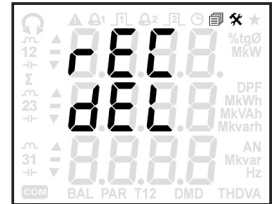

ENH instrument version

To select the recording type to be deleted, press **←** button, the item which identify the data type will start to blink. Available choices:

- **r=**=delete MIN/AVG/MAX recordings
- **rCnt**=delete energy counter recordings
- **rALL**=delete both MIN/AVG/MAX and energy counter recordings

With **↑** or **↓** button select the data type to be reset and confirm with **←** button.

A confirmation page (**CONF?**) will be displayed. With **↑** or **↓** button select the blinking item:

- **YES**=delete the selected recordings
- **NO**=no deletion is performed

Confirm with **←** button. The last displayed page will be shown.



8.15.20 Password setup

By this page, it is possible to display the current password for Setup loop access and change it. The default password is 0000. To change password, press **←** button, the first digit will start to blink. With **↑** or **↓** button select the digit and confirm with **M/▶** button. Repeat the same procedure for the other digits. At the end, press **←** button to confirm the whole password.



8.16 LOOP 6 - INFO

In this loop, the instrument information is displayed according to the instrument model.

Scroll the loop pages with **▲** or **▼** button.

The following pages refer to the full optional instrument version with RS485 port.

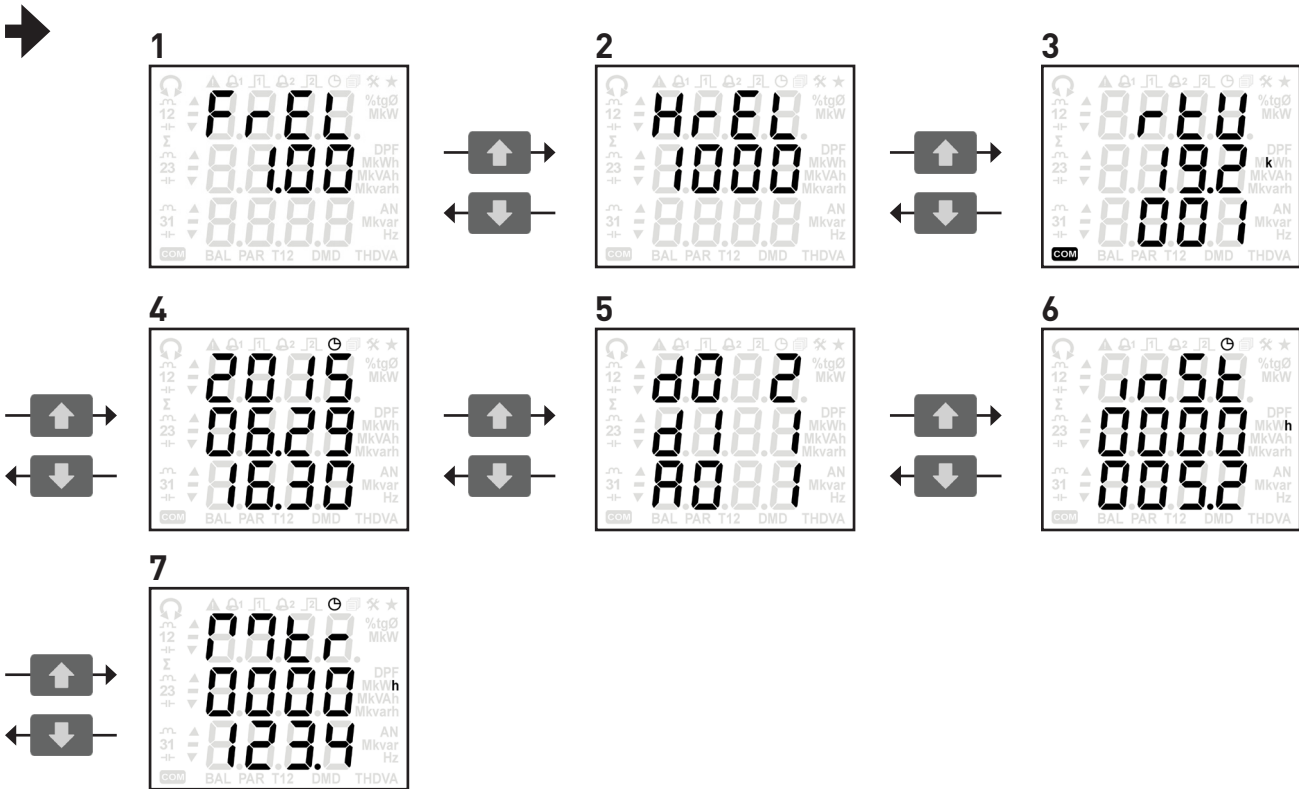

The following table shows the information available according to the instrument model. The column "PAGE" shows the number of the corresponding device page just shown in this section.

INSTRUMENT INFORMATION	PAGE
Firmware release	1
Hardware version	2
Communication settings: <ul style="list-style-type: none"> with RS485 port: MODBUS mode, communication speed, MODBUS address with ETHERNET port: only "ETH" item is shown 	3
Clock (YYYY, MM.DD, hh.mm)	4
Available inputs & outputs number (I/O), according to the instrument model: <ul style="list-style-type: none"> DI=digital input DO=digital output AO=analog output 	5
Installation hourcounter (Inst), <u>only with ENH instrument version</u> : time elapsed (in hour) from the first instrument switching on.	6
Measurement hourcounter (Mtr) <u>only with ENH instrument version</u> : time spent (in hour) for the instrument measurements (measurement condition: at least one phase current must be $>I_{st}$).	7

9. TECHNICAL SPECIFICATIONS

POWER SUPPLY

Supply voltage (according to the model):	Instrument with RS485 port: 230 VAC ±15% 115 VAC ±15% on request 85...265 VAC / 110 VDC ±15% on request
Safety:	Instrument with Ethernet port: 85...265 VAC / 110 VDC ±15% 300 V CAT III
Maximum consumption:	Instrument with RS485 port: 2.7 VA Instrument with Ethernet port: 5.8 VA
T type fuse (to be mounted externally):	250 mA
Frequency:	50/60 Hz

VOLTAGE INPUTS

Maximum measurable voltage:	600 VAC L-L
Safety:	300 V CAT III
Minimum voltage for FFT calculation:	20/35 VAC (multiplied by PT ratio in case of PT use) with direct connection
Input impedance:	>1.3 MOhm
Frequency:	45 - 65 Hz

CURRENT INPUTS

Maximum value:	1/5A CT model: 7A Rogowski model: 3 selectable scales, 500/4000/20000 A
CT burden (only for 1/5A CT model):	max 0.15 VA per phase
Starting current (I_{st}):	1/5A CT model: 2 mA Rogowski model: 300 mA
Minimum current for FFT calculation:	1/5A CT model: 100 mA * CT ratio Rogowski model: 70 A for FSA 500 A, 400 A for FSA 4000 A, 1500 A for FSA 20000 A - 2% harmonic accuracy ±2 digits

TYPICAL ACCURACY / PERFORMANCE CLASS (device only)

Voltage:	±0.2% reading in 10% FS...FS range (FS=Full Scale value)
Current:	±0.4% reading in 5% FS...FS range
Frequency:	±0.1% reading ±1 digit in 45...65 Hz range
Active power/energy:	Class 0.5 according to IEC/EN 61557-12
Reactive power/energy:	Class 2 according to IEC/EN 61557-12

DISPLAY & KEYBOARD

Display:	Backlighted LCD, 78x61 mm 3 rows, 4 digits + symbols
Keyboard:	4 front buttons

COMMUNICATION PORT

Type:	RS485 optoisolated or Ethernet
Protocols:	MODBUS RTU in case of RS485 port HTTP, NTP, DHCP, MODBUS TCP in case of Ethernet port
Baud rate:	300 a 57600 bps in case of RS485 port 10/100 Mbps in case of Ethernet port

2 DIGITAL OUTPUTS (DO)

Type:	NPN or PNP, passive optoisolated
Maximum values (according to IEC/EN 62053-31):	27 V _{DC} - 27 mA
Energy pulse length (only for DO in pulse mode):	50 ±2ms ON time
Max output reaction time (only for DO in alarm mode):	1 s

ANALOG OUTPUT (AO)

Type:	Active optoisolated
Selectable ranges:	0 ... 20 / 4 ... 20 mADC
Maximum load:	500 Ω

DIGITAL INPUT (DI)

Type:	Optoisolated
Voltage range:	80 ... 265 VAC-DC

WIRE DIAMETER FOR TERMINALS

Measuring terminals (A&V):	2.5 mm ² / 14 AWG
Terminals for I/O, AUX, RS485 port, Rogowski inputs:	1.5 mm ² / 16 AWG

SIZE & WEIGHT

LxHxP, W:	96x96x39 mm, max 310 g
-----------	------------------------

ENVIRONMENTAL CONDITIONS

Operating temperature:	-25°C ... +55°C (3K6)
Storage temperature:	-25°C ... +75°C (2K3)
Max humidity (without condensation):	80%
Sinusoidal vibration amplitude:	50 Hz ±0.075 mm
Protection degree - frontal part:	IP54 (granted only in case of installation in a cabinet with at least IP54 protection degree)
Protection degree - terminals:	IP20
Pollution degree:	2
Installation and use:	Internal

STANDARD COMPLIANCE (for the parts applicable for the instrument)

Directives:	2014/30/EU, 2014/35/EU
Safety:	EN 61010-1, EN 61010-2-030, EN 61010-2-032
EMC:	EN 61326-1, EN 55011, EN 61000-4-2, EN 61000-4-3, EN 61000-4-4, EN 61000-4-5, EN 61000-4-6, EN 61000-4-11, EN 61000-6-2

MODBUS

Communication Protocol

INDEX • Modbus protocol

1. Description	49
1.1 LRC GENERATION.....	50
1.2 CRC GENERATION	51
2. Command structure	54
2.1 MODBUS RTU.....	54
2.2 MODBUS TCP.....	56
2.3 FLOATING POINT AS PER IEEE STANDARD	58
3. Exception codes	59
3.1 MODBUS RTU.....	59
3.2 MODBUS TCP.....	59
4. Register tables	61
4.1 READING REGISTERS (FUNCTION CODE \$03 / \$04)	62
4.2 READING AND WRITING REGISTERS (FUNCTION CODE \$03 / \$04 / \$10)	72
4.3 CONSIDERATIONS ON THE FULL SCALE VALUE CALCULATION	88
5. Reading command examples	89
5.1 MODBUS RTU.....	89
5.2 MODBUS TCP.....	90
6. Writing command examples	93
6.1 MODBUS RTU.....	93
6.2 MODBUS TCP.....	99

1. DESCRIPTION

MODBUS RTU is a master-slave communication protocol, able to support up to 247 slaves connected in a bus or a star network.

The protocol uses a simplex connection on a single line. In this way, the communication messages move on a single line in two opposite directions.

MODBUS TCP is a variant of the MODBUS family. Specifically, it covers the use of MODBUS messaging in an "Intranet" or "Internet" environment using the TCP/IP protocol on a fixed port **502**.

Master-slave messages can be:

- **Reading (Function code \$03 / \$04):** the communication is between the master and a single slave. It allows to read information about the queried instrument.
- **Writing (Function code \$10):** the communication is between the master and a single slave. It allows to change the instrument settings.
- **Broadcast:** the communication is between the master and all the connected slaves. It is always a write command (Function code \$10) requiring MODBUS address \$00, and has no response by slaves. This functionality can be used only with register \$2040.

In a multi-point type connection (MODBUS RTU), **slave address** (called also **MODBUS address**) allows to identify each instrument during the communication. Each instrument is preset with a default slave address (01) and the user can change it.

In case of MODBUS TCP, slave address is replaced by a single byte, the **Unit ID**.

COMMUNICATION FRAME STRUCTURE

RTU mode:

Bit per byte: 1 Start, 8 Bit, None, 1 Stop (8N1)

Name	Length	Function
START FRAME	4 chars idle	At least 4 character time of silence (MARK condition)
ADDRESS FIELD	8 bits	Instrument MODBUS address
FUNCTION CODE	8 bits	Function code (\$03 / \$04 / \$10)
DATA FIELD	n x 8 bits	Data + length will be filled depending on the message type
ERROR CHECK	16 bits	Error check (CRC)
END FRAME	4 chars idle	At least 4 character time of silence between frames

TCP mode

Bit per byte: 1 Start, 7 Bit, Even, 2 Stop (7E2)

Name	Length	Function
TRANSACTION ID	2 bytes	For synchronization between messages of server & client
PROTOCOL ID	2 bytes	Zero for MODBUS TCP
BYTE COUNT	2 bytes	Number of remaining bytes in this frame
UNIT ID	1 byte	Slave address (\$FF if not used)
FUNCTION CODE	1 byte	Function code (\$01 / \$04 / \$10)
DATA BYTES	n bytes	Data as response or command

1.1 LRC GENERATION

The Longitudinal Redundancy Check (LRC) field is one byte, containing an 8-bit binary value. The LRC value is calculated by the transmitting device, which appends the LRC to the message. The receiving device recalculates an LRC during receipt of the message, and compares the calculated value to the actual value it received in the LRC field. If the two values are not equal, an error results. The LRC is calculated by adding together successive 8-bit bytes in the message, discarding any carries, and then two's complementing the result. The LRC is an 8-bit field, therefore each new addition of a character that would result in a value higher than 255 decimal simply 'rolls over' the field's value through zero. Because there is no ninth bit, the carry is discarded automatically.

A procedure for generating an LRC is:

1. Add all bytes in the message, excluding the starting 'colon' and ending CR LF. Add them into an 8-bit field, so that carries will be discarded.
2. Subtract the final field value from \$FF, to produce the ones-complement.
3. Add 1 to produce the twos-complement.

PLACING THE LRC INTO THE MESSAGE

When the the 8-bit LRC (2 ASCII characters) is transmitted in the message, the high-order character will be transmitted first, followed by the low-order character. For example, if the LRC value is \$52 (0101 0010):

Colon '.'	Addr	Func	Data Count	Data	Data	...	Data	LRC Hi '5'	LRC Lo '2'	CR	LF
--------------	------	------	---------------	------	------	-----	------	---------------	---------------	----	----

C-FUNCTION TO CALCULATE LRC

```
*pucFrame - pointer on "Addr" of message
usLen - length message from "Addr" to end "Data"

UCHAR prvucMBLRC( UCHAR * pucFrame, USHORT usLen )
{
    UCHAR          ucLRC = 0; /* LRC char initialized */

    while( usLen-- )
    {
        ucLRC += *pucFrame++; /* Add buffer byte without carry */
    }

    /* Return twos complement */
    ucLRC = ( UCHAR ) ( -( ( CHAR ) ucLRC ) );
    return ucLRC;
}
```

1.2 CRC GENERATION

The Cyclical Redundancy Check (CRC) field is two bytes, containing a 16-bit value. The CRC value is calculated by the transmitting device, which appends the CRC to the message. The receiving device recalculates a CRC during receipt of the message, and compares the calculated value to the actual value it received in the CRC field. If the two values are not equal, an error results.

The CRC is started by first preloading a 16-bit register to all 1's. Then a process begins of applying successive 8-bit bytes of the message to the current contents of the register. Only the eight bits of data in each character are used for generating the CRC. Start and stop bits, and the parity bit, do not apply to the CRC.

During generation of the CRC, each 8-bit character is exclusive ORed with the register contents. Then the result is shifted in the direction of the least significant bit (LSB), with a zero filled into the most significant bit (MSB) position. The LSB is extracted and examined. If the LSB was a 1, the register is then exclusive ORed with a preset, fixed value. If the LSB was a 0, no exclusive OR takes place.

This process is repeated until eight shifts have been performed. After the last (eighth) shift, the next 8-bit character is exclusive ORed with the register's current value, and the process repeats for eight more shifts as described above. The final contents of the register, after all the characters of the message have been applied, is the CRC value.

A calculated procedure for generating a CRC is:

1. Load a 16-bit register with \$FFFF. Call this the CRC register.
2. Exclusive OR the first 8-bit byte of the message with the low-order byte of the 16-bit CRC register, putting the result in the CRC register.
3. Shift the CRC register one bit to the right (toward the LSB), zero-filling the MSB. Extract and examine the LSB.
4. (If the LSB was 0): Repeat Step 3 (another shift).
(If the LSB was 1): Exclusive OR the CRC register with the polynomial value \$A001 (1010 0000 0000 0001).
5. Repeat Steps 3 and 4 until 8 shifts have been performed. When this is done, a complete 8-bit byte will have been processed.
6. Repeat Steps 2 through 5 for the next 8-bit byte of the message. Continue doing this until all bytes have been processed.
7. The final contents of the CRC register is the CRC value.
8. When the CRC is placed into the message, its upper and lower bytes must be swapped as described below.

PLACING THE CRC INTO THE MESSAGE

When the 16-bit CRC (two 8-bit bytes) is transmitted in the message, the low-order byte will be transmitted first, followed by the high-order byte.

For example, if the CRC value is \$35F7 (0011 0101 1111 0111):

Addr	Func	Data Count	Data	Data	...	Data	CRC lo F7	CRC hi 35
------	------	---------------	------	------	-----	------	--------------	--------------

CRC GENERATION FUNCTIONS - With Table

All of the possible CRC values are preloaded into two arrays, which are simply indexed as the function increments through the message buffer. One array contains all of the 256 possible CRC values for the high byte of the 16-bit CRC field, and the other array contains all of the values for the low byte. Indexing the CRC in this way provides faster execution than would be achieved by calculating a new CRC value with each new character from the message buffer.

```
/*CRC table for calculate with polynom 0xA001 with init value 0xFFFF, High half word*/
rom unsigned char CRC_Table_Hi[] = {
    0x00, 0xC1, 0x81, 0x40, 0x01, 0xC0, 0x80, 0x41, 0x01, 0xC0, 0x80, 0x41, 0x00, 0xC1, 0x81,
    0x40, 0x01, 0xC0, 0x80, 0x41, 0x00, 0xC1, 0x81, 0x40, 0x00, 0xC1, 0x81, 0x40, 0x01, 0xC0,
    0x80, 0x41, 0x01, 0xC0, 0x80, 0x41, 0x00, 0xC1, 0x81, 0x40, 0x00, 0xC1, 0x81, 0x40, 0x01,
    0xC0, 0x80, 0x41, 0x00, 0xC1, 0x81, 0x40, 0x01, 0xC0, 0x80, 0x41, 0x01, 0xC0, 0x80, 0x41,
    0x00, 0xC1, 0x81, 0x40, 0x01, 0xC0, 0x80, 0x41, 0x00, 0xC1, 0x81, 0x40, 0x00, 0xC1, 0x81,
    0x40, 0x01, 0xC0, 0x80, 0x41, 0x00, 0xC1, 0x81, 0x40, 0x01, 0xC0, 0x80, 0x41, 0x01, 0xC0,
    0x80, 0x41, 0x00, 0xC1, 0x81, 0x40, 0x00, 0xC1, 0x81, 0x40, 0x01, 0xC0, 0x80, 0x41, 0x01,
    0xC0, 0x80, 0x41, 0x00, 0xC1, 0x81, 0x40, 0x01, 0xC0, 0x80, 0x41, 0x00, 0xC1, 0x81, 0x40,
    0x00, 0xC1, 0x81, 0x40, 0x01, 0xC0, 0x80, 0x41, 0x01, 0xC0, 0x80, 0x41, 0x00, 0xC1, 0x81,
    0x40, 0x00, 0xC1, 0x81, 0x40, 0x01, 0xC0, 0x80, 0x41, 0x00, 0xC1, 0x81, 0x40, 0x01, 0xC0,
    0x80, 0x41, 0x01, 0xC0, 0x80, 0x41, 0x00, 0xC1, 0x81, 0x40, 0x00, 0xC1, 0x81, 0x40, 0x01,
    0xC0, 0x80, 0x41, 0x01, 0xC0, 0x80, 0x41, 0x00, 0xC1, 0x81, 0x40, 0x01, 0xC0, 0x80, 0x41,
    0x01, 0xC0, 0x80, 0x41, 0x00, 0xC1, 0x81, 0x40, 0x01, 0xC0, 0x80, 0x41, 0x01, 0xC0, 0x80,
    0x41, 0x00, 0xC1, 0x81, 0x40, 0x00, 0xC1, 0x81, 0x40, 0x01, 0xC0, 0x80, 0x41, 0x01, 0xC0,
    0x80, 0x41, 0x00, 0xC1, 0x81, 0x40, 0x00, 0xC1, 0x81, 0x40, 0x01, 0xC0, 0x80, 0x41, 0x01,
    0xC0, 0x80, 0x41, 0x00, 0xC1, 0x81, 0x40, 0x00, 0xC1, 0x81, 0x40, 0x01, 0xC0, 0x80, 0x41,
    0x01, 0xC0, 0x80, 0x41, 0x00, 0xC1, 0x81, 0x40, 0x01, 0xC0, 0x80, 0x41, 0x00, 0xC1, 0x81,
    0x40,
    0x40
};
/*CRC table for calculate with polynom 0xA001 with init value 0xFFFF, Low half word*/
rom unsigned char CRC_Table_Lo[] = {
    0x00, 0xC0, 0xC1, 0x01, 0xC3, 0x03, 0xC2, 0xC6, 0x06, 0x07, 0xC7, 0x05, 0xC5, 0xC4,
    0x04, 0xCC, 0x0C, 0x0D, 0xCD, 0x0F, 0xCF, 0xCE, 0x0E, 0x0A, 0xCA, 0xCB, 0x0B, 0xC9, 0x09,
    0x08, 0xC8, 0xD8, 0x18, 0x19, 0xD9, 0x1B, 0xDB, 0xDA, 0x1A, 0x1E, 0xDE, 0xDF, 0x1F, 0xDD,
    0x1D, 0x1C, 0xDC, 0x14, 0xD4, 0xD5, 0x15, 0xD7, 0x17, 0x16, 0xD6, 0xD2, 0x12, 0x13, 0xD3,
    0x11, 0xD1, 0xD0, 0x10, 0xF0, 0x30, 0x31, 0xF1, 0x33, 0xF3, 0xF2, 0x32, 0x36, 0xF6, 0xF7,
    0x37, 0xF5, 0x35, 0x34, 0xF4, 0x3C, 0xFC, 0xFD, 0x3D, 0xFF, 0x3F, 0x3E, 0xFE, 0xFA, 0x3A,
    0x3B, 0xFB, 0x39, 0xF9, 0xF8, 0x38, 0x28, 0xE8, 0xE9, 0x29, 0xEB, 0x2B, 0x2A, 0xEA, 0xEE,
    0x2E, 0x2F, 0xEF, 0x2D, 0xED, 0xEC, 0x2C, 0xE4, 0x24, 0x25, 0xE5, 0x27, 0xE7, 0xE6, 0x26,
    0x22, 0xE2, 0xE3, 0x23, 0xE1, 0x21, 0x20, 0xE0, 0xA0, 0x60, 0x61, 0xA1, 0x63, 0xA3, 0xA2,
    0x62, 0x66, 0xA6, 0xA7, 0x67, 0xA5, 0x65, 0x64, 0xA4, 0x6C, 0xAC, 0xAD, 0x6D, 0xAF, 0x6F,
    0x6E, 0xAE, 0xAA, 0x6A, 0x6B, 0xAB, 0x6B, 0x69, 0xA9, 0xA8, 0x68, 0x78, 0xB8, 0xB9, 0x79, 0xBB,
    0x7B, 0x7A, 0xBA, 0xBE, 0x7E, 0xBF, 0x7D, 0xBD, 0xBC, 0x7C, 0xB4, 0xB5, 0x74, 0x75, 0xB5,
    0x77, 0xB7, 0xB6, 0x76, 0x72, 0xB2, 0xB3, 0x73, 0xB1, 0x71, 0x70, 0xB0, 0x50, 0x90, 0x91,
    0x51, 0x93, 0x53, 0x52, 0x92, 0x96, 0x56, 0x57, 0x97, 0x55, 0x95, 0x94, 0x54, 0x9C, 0x5C,
    0x5D, 0x9D, 0x5F, 0x9F, 0x9E, 0x5E, 0x5A, 0x9A, 0x9B, 0x5B, 0x99, 0x59, 0x58, 0x98, 0x88,
    0x48, 0x49, 0x89, 0x4B, 0x8B, 0x8A, 0x4A, 0x4E, 0x8E, 0x8F, 0x4F, 0x8D, 0x4D, 0x4C, 0x8C,
    0x44, 0x84, 0x85, 0x45, 0x87, 0x47, 0x46, 0x86, 0x82, 0x42, 0x43, 0x83, 0x41, 0x81, 0x80,
    0x40
};
};

unsigned short ModBus_CRC16( unsigned char * Buffer, unsigned short Length )
{
    unsigned char CRCHi = 0xFF;
    unsigned char CRCLo = 0xFF;
    int Index;
    unsigned short ret;

    while( Length-- )
    {
        Index = CRCLo ^ *Buffer++;
        CRCLo = CRCHi ^ CRC_Table_Hi[Index];
        CRCHi = CRC_Table_Lo[Index];
    }
    ret=((unsigned short)CRCHi << 8);
    ret|= (unsigned short)CRCLo;
    return ret;
}
```

CRC GENERATION FUNCTIONS - Without Table

```
unsigned short ModBus_CRC16( unsigned char * Buffer, unsigned short Length )
{
/* ModBus_CRC16 Calculatd CRC16 with polynome 0xA001 and init value 0xFFFF
Input *Buffer - pointer on data
Input Lenght - number byte in buffer
Output - calculated CRC16
*/
    unsigned int cur_crc;

    cur_crc=0xFFFF;
    do
    {
        unsigned int i = 8;
        cur_crc = cur_crc ^ *Buffer++;
        do
        {
            if (0x0001 & cur_crc)
            {
                cur_crc >>= 1;
                cur_crc ^= 0xA001;
            }
            else
            {
                cur_crc >>= 1;
            }
        }
        while (--i);
    }
    while (--Length);

    return cur_crc;
}
```

2. COMMAND STRUCTURE

The master communication device can send reading or writing commands to the slave (instrument). The structure for reading and writing commands is following described according to the used communication protocol (RTU or TCP).

2.1 MODBUS RTU

In this section, the tables describe the reading command structure (Query) and the writing command structure. Both commands are followed by a response sent by slave.

These tables refer to a master-slave communication in MODBUS RTU.

READING COMMAND STRUCTURE (function code \$03/\$04)

The master communication device can send commands to the instrument to read its status, setup and the measured values. More registers can be read, at the same time, sending a single command, only if the registers are consecutive (see chapter 4). Values contained both in Query and Response messages are in hex format.

Structure	Example	Byte
Slave address	01	-
Function code	03	-
Starting register	00	High
	00	Low
Words to be read	00	High
	02	Low
CRC	0B	High
	C4	Low

Query example: 0103000000020BC4

Structure	Example	Byte
Slave address	01	-
Function code	03	-
Data bytes	04	-
Requested reading data	00	High
	03	Low
	92	High
	10	Low
CRC	9F	High
	66	Low

Response example: 010304000392109F66

WRITING COMMAND STRUCTURE (function code \$10)

The master communication device can send commands to the instrument for setup. More settings can be carried out, at the same time, sending a single command, only if the relevant registers are consecutive (see chapter 4). Values contained both in Command and Response messages are in hex format.

Structure	Example	Byte
Slave address	01	-
Function code	10	-
Starting register	20	High
	3C	Low
Words to be written	00	High
	02	Low
Data bytes	04	-
	00	High
Programming data to be written	00	Low
	00	High
	03	Low
	03	High
CRC	2E	High
	29	Low

Command example: 0110203C000204000000032E29

Structure	Example	Byte
Slave address	01	-
Function code	10	-
Starting register	20	High
	3C	Low
Written words	00	High
	02	Low
CRC	04	High
	8A	Low

Response example: 0110203C0002048A

2.2 MODBUS TCP

In this section, the tables describe the reading command structure (Query) and the writing command structure. Both commands are followed by a response sent by slave.

These tables refer to a master-slave communication in MODBUS TCP.

READING COMMAND STRUCTURE

The master communication device can send commands to the instrument to read its status, setup and the measured values. More registers can be read, at the same time, sending a single command, only if the registers are consecutive (see chapter 4). Values contained both in Query and Response messages are in hex format.

Structure	Example	Byte
Transaction ID	01	-
Protocol ID	00	High
	00	Low
	00	High
	00	Low
Data bytes	06	-
Unit ID	01	-
Function code	03	-
Starting register	00	High
	00	Low
Words to be read	00	High
	02	Low

Query example: 010000000006010300000002

Structure	Example	Byte
Transaction ID	01	-
Protocol ID	00	High
	00	Low
	00	High
	00	Low
Data bytes	07	-
Unit ID	01	-
Function code	03	-
Reading bytes	04	-
Requested reading data	00	High
	03	Low
	92	High
	10	Low

Response example: 01000000000701030400039210

WRITING COMMAND STRUCTURE (function code \$10)

The master communication device can send commands to the instrument for setup. More settings can be carried out, at the same time, sending a single command, only if the relevant registers are consecutive (see chapter 4). Values contained both in Command and Response messages are in hex format.

Structure	Example	Byte
Transaction ID	01	-
	00	High
Protocol ID	00	Low
	00	High
	00	Low
Data bytes	0B	-
Unit ID	01	-
Function code	10	-
Starting register	20	High
	3C	Low
Words to be written	00	High
	02	Low
Bytes to be written	04	-
	00	High
	00	Low
Programming data to be written	00	High
	03	Low

Command example: 0100000000B0110203C0002040000003

Structure	Example	Byte
Transaction ID	01	-
	00	High
Protocol ID	00	Low
	00	High
	00	Low
Data bytes	06	-
Unit ID	01	-
Function code	10	-
Starting register	20	High
	3C	Low
Command successfully sent	00	High
	01	Low

Response example: 0100000000060110203C0001

2.3 FLOATING POINT AS PER IEEE STANDARD

The basic format allows a IEEE standard floating-point number to be represented in a single 32 bit format, as shown below:

$$N.n = (-1)^S 2^{e-127} (1.f)$$

where **S** is the sign bit, **e'** is the first part of the exponent and **f** is the decimal fraction placed next to 1. Internally the exponent is 8 bits in length and the stored fraction is 23 bits long.

A round to nearest method is applied to the calculated value of floating point.

The floating-point format is shown as follows:

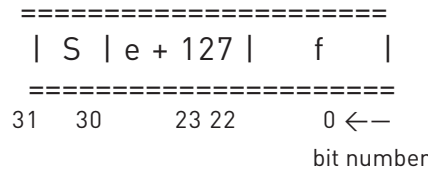

where:

	bit length
Sign	1
Exponent	8
Fraction	23 + (1)
Total	m = 32 + (1)
Exponent	
Min e'	0
Max e'	255
Bias	127



NOTE. Fractions (decimals) are always shown while the leading 1 (hidden bit) is not stored.

EXAMPLE OF CONVERSION OF VALUE SHOWN WITH FLOATING POINT

Value read with floating point:

$$45AACC00_{(16)}$$

Value converted in binary format:

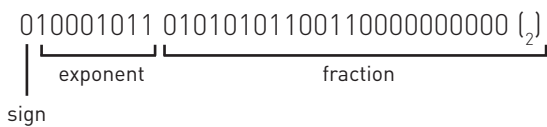

$$\text{sign} = 0$$

$$\text{exponent} = 10001011_2 = 139_{10}$$

$$\begin{aligned} \text{fraction} &= 010101011001100000000000_2 / 8388608_{10} = \\ &= 2804736_{10} / 8388608_{10} = 0.334350585_{10} \end{aligned}$$

$$\begin{aligned} N.n &= (-1)^S 2^{e-127} (1+f) = \\ &= (-1)^0 2^{139-127} (1.334350585) = \\ &= (+1) (4096) (1.334350585) = \\ &= 5465.5 \end{aligned}$$

3. EXCEPTION CODES

When the slave (instrument) receives a not-valid query or command, an error response is sent. The error response structure is following described according to the used communication protocol (RTU or TCP).

3.1 MODBUS RTU

In this section, the table describes the error response structure following to a not-valid query or command. This table refers to a master-slave communication in MODBUS RTU.

Values contained in Response messages are in hex format.

Structure	Example	Byte
Slave address	01	-
Function code + \$80 (e.g. 03+80, 04+80, 10+80, according to the query/command)	83	-
Exception code	01	-
CRC	F0	High
	80	Low

Response example: 018301F080

Exception codes for MODBUS RTU are following described:

- \$01 ILLEGAL FUNCTION:** the function code received in the query is not an allowable action.
- \$02 ILLEGAL DATA ADDRESS:** the data address received in the query is not an allowable address (e.g. the combination of register and transfer length is invalid).
- \$03 ILLEGAL DATA VALUE:** a value contained in the query data field is not an allowable value.
- \$04 ILLEGAL RESPONSE LENGTH:** the request would generate a response with size bigger than that available for MODBUS protocol.

3.2 MODBUS TCP

In this section, the table describes the error response structure following to a not-valid query or command. This table refers to a master-slave communication in MODBUS TCP.

Values contained in Response messages are in hex format.

Structure	Example	Byte
Transaction ID	01	-
Protocol ID	00	High
	00	Low
	00	High
	00	Low
Data bytes	03	-
Unit ID	01	-
Function code + \$80 (e.g. 03+80, 04+80, 10+80, according to the query/command)	83	-
Exception code	01	-

Response example: 010000000003018301

Exception codes for MODBUS TCP are following described:

- \$01 ILLEGAL FUNCTION:** the function code is unknown by the server.
- \$02 ILLEGAL DATA ADDRESS:** the data address received in the query is not an allowable address for the slave (i.e. the combination of register and transfer length is invalid).
- \$03 ILLEGAL DATA VALUE:** a value contained in the query data field is not an allowable value for the slave.
- \$04 SERVER FAILURE:** the server failed during the execution.
- \$05 ACKNOWLEDGE:** the server accepted the server invocation but the service requires a relatively long time to execute. The server therefore returns only an acknowledgement of the service invocation receipt.
- \$06 SERVER BUSY:** the server was unable to accept the MB request PDU. The client application has the responsibility of deciding if and when re-sending the request.
- \$0A GATEWAY PATH UNAVAILABLE:** the slave is not configured or cannot communicate.
- \$0B GATEWAY TARGET DEVICE FAILED TO RESPOND:** the slave is not available in the network.

4. REGISTER TABLES



NOTE. Highest number of registers (or bytes) which can be read with a single command:

- in RTU mode: 127 registers
- in TCP mode: 256 bytes



NOTE. Highest number of registers which can be programmed with a single command:

- in RTU mode: 29 registers
- in TCP mode: 1 register



NOTE. The register values are in hex format (\$).



NOTE. The following registers describe all parameters for any instrument configuration. Refer to the instrument model before sending reading/writing commands: some register parameters may not be available.

TABLE HEADER	MEANING																
Parameter	Measuring parameter to be read																
Register description	Description of the register to be read / written																
F. code (Hex)	Function code in hex format. It identifies the command type (reading / writing)																
Sign	<p>If this column is checked, the read register value can have positive or negative sign. The value conversion changes according to the instrument model.</p> <table border="0" style="width: 100%;"> <tr> <td style="text-align: center; width: 50%;">SIGN BIT</td> <td style="text-align: center; width: 50%;">2'S COMPLEMENT</td> </tr> <tr> <td> <p>Convert a signed register value as shown in the following instructions:</p> <p>The Most Significant Bit (MSB) indicates the sign as follows: 0=positive (+), 1=negative (-).</p> <p><u>NEGATIVE VALUE EXAMPLE:</u></p> <table border="0" style="margin-left: auto; margin-right: auto;"> <tr> <td style="text-align: center;">MSB</td> <td></td> <td></td> <td></td> </tr> <tr> <td style="text-align: center;">\$8020 =</td> <td style="text-align: center;">1</td> <td style="text-align: center;">0000000000</td> <td style="text-align: center;">1000000 = -32</td> </tr> <tr> <td style="text-align: center;">HEX</td> <td></td> <td style="text-align: center;">BIN</td> <td style="text-align: center;">DEC</td> </tr> </table> </td> <td> <p>The negative values are represented with 2's complement.</p> </td> </tr> </table>	SIGN BIT	2'S COMPLEMENT	<p>Convert a signed register value as shown in the following instructions:</p> <p>The Most Significant Bit (MSB) indicates the sign as follows: 0=positive (+), 1=negative (-).</p> <p><u>NEGATIVE VALUE EXAMPLE:</u></p> <table border="0" style="margin-left: auto; margin-right: auto;"> <tr> <td style="text-align: center;">MSB</td> <td></td> <td></td> <td></td> </tr> <tr> <td style="text-align: center;">\$8020 =</td> <td style="text-align: center;">1</td> <td style="text-align: center;">0000000000</td> <td style="text-align: center;">1000000 = -32</td> </tr> <tr> <td style="text-align: center;">HEX</td> <td></td> <td style="text-align: center;">BIN</td> <td style="text-align: center;">DEC</td> </tr> </table>	MSB				\$8020 =	1	0000000000	1000000 = -32	HEX		BIN	DEC	<p>The negative values are represented with 2's complement.</p>
SIGN BIT	2'S COMPLEMENT																
<p>Convert a signed register value as shown in the following instructions:</p> <p>The Most Significant Bit (MSB) indicates the sign as follows: 0=positive (+), 1=negative (-).</p> <p><u>NEGATIVE VALUE EXAMPLE:</u></p> <table border="0" style="margin-left: auto; margin-right: auto;"> <tr> <td style="text-align: center;">MSB</td> <td></td> <td></td> <td></td> </tr> <tr> <td style="text-align: center;">\$8020 =</td> <td style="text-align: center;">1</td> <td style="text-align: center;">0000000000</td> <td style="text-align: center;">1000000 = -32</td> </tr> <tr> <td style="text-align: center;">HEX</td> <td></td> <td style="text-align: center;">BIN</td> <td style="text-align: center;">DEC</td> </tr> </table>	MSB				\$8020 =	1	0000000000	1000000 = -32	HEX		BIN	DEC	<p>The negative values are represented with 2's complement.</p>				
MSB																	
\$8020 =	1	0000000000	1000000 = -32														
HEX		BIN	DEC														
INTEGER	Details for INTEGER type registers																
IEEE	Details for IEEE standard type registers																
Register (Hex)	Register address in hex format																
Words	Number of word to be read / written for the register (length)																
M.U.	Measuring unit of parameter																
Data meaning	Description of data received by a response of a reading command																
Programmable data	Description of data which can be sent for a writing command																

4.1 READING REGISTERS (FUNCTION CODE \$03 / \$04)

Parameter	F. code (Hex)	Sign	INTEGER			IEEE		
			Register (Hex)	Words	M.U.	Register (Hex)	Words	M.U.
REAL TIME VALUES								
V1 • Phase 1-N voltage	03 / 04		0000	2	mV	1000	2	V
V2 • Phase 2-N voltage	03 / 04		0002	2	mV	1002	2	V
V3 • Phase 3-N voltage	03 / 04		0004	2	mV	1004	2	V
V12 • Line 12 voltage	03 / 04		0006	2	mV	1006	2	V
V23 • Line 23 voltage	03 / 04		0008	2	mV	1008	2	V
V31 • Line 31 voltage	03 / 04		000A	2	mV	100A	2	V
V Σ • System voltage	03 / 04		000C	2	mV	100C	2	V
A1 • Phase 1 current	03 / 04	X	000E	2	mA	100E	2	A
A2 • Phase 2 current	03 / 04	X	0010	2	mA	1010	2	A
A3 • Phase 3 current	03 / 04	X	0012	2	mA	1012	2	A
AN • Neutral current*	03 / 04	X	0014	2	mA	1014	2	A
A Σ • System current	03 / 04	X	0016	2	mA	1016	2	A
P1 • Phase 1 active power	03 / 04	X	0018	4	mW	1018	2	W
P2 • Phase 2 active power	03 / 04	X	001C	4	mW	101A	2	W
P3 • Phase 3 active power	03 / 04	X	0020	4	mW	101C	2	W
P Σ • System active power	03 / 04	X	0024	4	mW	101E	2	W
S1 • Phase 1 apparent power	03 / 04	X	0028	4	mVA	1020	2	VA
S2 • Phase 2 apparent power	03 / 04	X	002C	4	mVA	1022	2	VA
S3 • Phase 3 apparent power	03 / 04	X	0030	4	mVA	1024	2	VA
S Σ • System apparent power	03 / 04	X	0034	4	mVA	1026	2	VA
Q1 • Phase 1 reactive power	03 / 04	X	0038	4	mvar	1028	2	var
Q2 • Phase 2 reactive power	03 / 04	X	003C	4	mvar	102A	2	var
Q3 • Phase 3 reactive power	03 / 04	X	0040	4	mvar	102C	2	var
Q Σ • System reactive power	03 / 04	X	0044	4	mvar	102E	2	var
PF1 • Phase 1 power factor	03 / 04	X	0048	2	0,001	1030	2	-
PF2 • Phase 2 power factor	03 / 04	X	004A	2	0,001	1032	2	-
PF3 • Phase 3 power factor	03 / 04	X	004C	2	0,001	1034	2	-
PF Σ • System power factor	03 / 04	X	004E	2	0,001	1036	2	-
DPF1 • Phase 1 DPF	03 / 04	X	0050	2	0,001	1038	2	-
DPF2 • Phase 2 DPF	03 / 04	X	0052	2	0,001	103A	2	-
DPF3 • Phase 3 DPF	03 / 04	X	0054	2	0,001	103C	2	-
TAN \emptyset 1 • Phase 1 tangent \emptyset	03 / 04	X	0056	2	0,001	103E	2	-
TAN \emptyset 2 • Phase 2 tangent \emptyset	03 / 04	X	0058	2	0,001	1040	2	-
TAN \emptyset 3 • Phase 3 tangent \emptyset	03 / 04	X	005A	2	0,001	1042	2	-
TAN $\emptyset\Sigma$ • System tangent \emptyset	03 / 04	X	005C	2	0,001	1044	2	-
THDV1 • Phase 1-N voltage THD	03 / 04		005E	2	m%	1046	2	%
THDV2 • Phase 2-N voltage THD	03 / 04		0060	2	m%	1048	2	%
THDV3 • Phase 3-N voltage THD	03 / 04		0062	2	m%	104A	2	%
THDV12 • Line 12 voltage THD	03 / 04		0064	2	m%	104C	2	%
THDV23 • Line 23 voltage THD	03 / 04		0066	2	m%	104E	2	%
THDV31 • Line 31 voltage THD	03 / 04		0068	2	m%	1050	2	%
THDA1 • Phase 1 current THD	03 / 04		006A	2	m%	1052	2	%
THDA2 • Phase 2 current THD	03 / 04		006C	2	m%	1054	2	%
THDA3 • Phase 3 current THD	03 / 04		006E	2	m%	1056	2	%
THDAN • Neutral current THD*	03 / 04		0070	2	m%	1058	2	%

■ Available only for ENH instrument version.

* The neutral current and the derivative parameters (AN, THDAN, HaAN) are not available if the set CT ratio or FSA value is different for each phase.

Parameter	F. code (Hex)	Sign	INTEGER			IEEE		
			Register (Hex)	Words	M.U.	Register (Hex)	Words	M.U.
REAL TIME VALUES								
F • Frequency	03 / 04		0072	2	mHz	105A	2	Hz
Phase sequence (\$00=123-CCW, \$01=321-CW, \$02=not defined)	03 / 04		0074	2	-	105C	2	-
Installation hourcounter	03 / 04		0076	2	0,1h	105E	2	h
Measurement hourcounter	03 / 04		0078	2	0,1h	1060	2	h
DEMAND VALUES (DMD)								
A1 _{DMD} • Phase 1 current DMD	03 / 04		010E	2	mA	110E	2	A
A2 _{DMD} • Phase 2 current DMD	03 / 04		0110	2	mA	1110	2	A
A3 _{DMD} • Phase 3 current DMD	03 / 04		0112	2	mA	1112	2	A
AN _{DMD} • Neutral current DMD*	03 / 04		0114	2	mA	1114	2	A
A Σ _{DMD} • System current DMD	03 / 04		0116	2	mA	1116	2	A
+P1 _{DMD} • Phase 1 imported active power DMD	03 / 04		0118	4	mW	1118	2	W
-P1 _{DMD} • Phase 1 exported active power DMD	03 / 04		011C	4	mW	111A	2	W
+P2 _{DMD} • Phase 2 imported active power DMD	03 / 04		0120	4	mW	111C	2	W
-P2 _{DMD} • Phase 2 exported active power DMD	03 / 04		0124	4	mW	111E	2	W
+P3 _{DMD} • Phase 3 imported active power DMD	03 / 04		0128	4	mW	1120	2	W
-P3 _{DMD} • Phase 3 exported active power DMD	03 / 04		012C	4	mW	1122	2	W
+P Σ _{DMD} • System imported active power DMD	03 / 04		0130	4	mW	1124	2	W
-P Σ _{DMD} • System exported active power DMD	03 / 04		0134	4	mW	1126	2	W
P Σ _{DMD} BAL • Balance of system active power DMD	03 / 04	X	0138	4	mW	1128	2	W
+S1 _{DMD} • Phase 1 imported apparent power DMD	03 / 04		013C	4	mVA	112A	2	VA
-S1 _{DMD} • Phase 1 exported apparent power DMD	03 / 04		0140	4	mVA	112C	2	VA
+S2 _{DMD} • Phase 2 imported apparent power DMD	03 / 04		0144	4	mVA	112E	2	VA
-S2 _{DMD} • Phase 2 exported apparent power DMD	03 / 04		0148	4	mVA	1130	2	VA
+S3 _{DMD} • Phase 3 imported apparent power DMD	03 / 04		014C	4	mVA	1132	2	VA
-S3 _{DMD} • Phase 3 exported apparent power DMD	03 / 04		0150	4	mVA	1134	2	VA
+S Σ _{DMD} • System imported apparent power DMD	03 / 04		0154	4	mVA	1136	2	VA
-S Σ _{DMD} • System exported apparent power DMD	03 / 04		0158	4	mVA	1138	2	VA
S Σ _{DMD} BAL • Balance of system apparent power DMD	03 / 04	X	015C	4	mVA	113A	2	VA
+Q1 _{DMD} • Phase 1 imported reactive power DMD	03 / 04		0160	4	mvar	113C	2	var
-Q1 _{DMD} • Phase 1 exported reactive power DMD	03 / 04		0164	4	mvar	113E	2	var
+Q2 _{DMD} • Phase 2 imported reactive power DMD	03 / 04		0168	4	mvar	1140	2	var
-Q2 _{DMD} • Phase 2 exported reactive power DMD	03 / 04		016C	4	mvar	1142	2	var
+Q3 _{DMD} • Phase 3 imported reactive power DMD	03 / 04		0170	4	mvar	1144	2	var
-Q3 _{DMD} • Phase 3 exported reactive power DMD	03 / 04		0174	4	mvar	1146	2	var
+Q Σ _{DMD} • System imported reactive power DMD	03 / 04		0178	4	mvar	1148	2	var
-Q Σ _{DMD} • System exported reactive power DMD	03 / 04		017C	4	mvar	114A	2	var
Q Σ _{DMD} BAL • Balance of system reactive power DMD	03 / 04	X	0180	4	mvar	114C	2	var
+PF1 _{DMD} • Phase 1 inductive power factor DMD	03 / 04		0184	2	0,001	114E	2	-
-PF1 _{DMD} • Phase 1 capacitive power factor DMD	03 / 04		0186	2	0,001	1150	2	-
+PF2 _{DMD} • Phase 2 inductive power factor DMD	03 / 04		0188	2	0,001	1152	2	-
-PF2 _{DMD} • Phase 2 capacitive power factor DMD	03 / 04		018A	2	0,001	1154	2	-
+PF3 _{DMD} • Phase 3 inductive power factor DMD	03 / 04		018C	2	0,001	1156	2	-
-PF3 _{DMD} • Phase 3 capacitive power factor DMD	03 / 04		018E	2	0,001	1158	2	-
+PF Σ _{DMD} • System inductive power factor DMD	03 / 04		0190	2	0,001	115A	2	-
-PF Σ _{DMD} • System capacitive power factor DMD	03 / 04		0192	2	0,001	115C	2	-

■ Available only for ENH instrument version.

* The neutral current and the derivative parameters (AN, THDAN, HaAN) are not available if the set CT ratio or FSA value is different for each phase.

Parameter	F. code (Hex)	Sign	INTEGER			IEEE		
			Register (Hex)	Words	M.U.	Register (Hex)	Words	M.U.
MAXIMUM VALUES								
V1 _{MAX} • Phase 1-N voltage MAX	03 / 04		0200	2	mV	1200	2	V
V2 _{MAX} • Phase 2-N voltage MAX	03 / 04		0202	2	mV	1202	2	V
V3 _{MAX} • Phase 3-N voltage MAX	03 / 04		0204	2	mV	1204	2	V
V12 _{MAX} • Line 12 voltage MAX	03 / 04		0206	2	mV	1206	2	V
V23 _{MAX} • Line 23 voltage MAX	03 / 04		0208	2	mV	1208	2	V
V31 _{MAX} • Line 31 voltage MAX	03 / 04		020A	2	mV	120A	2	V
V _{ΣMAX} • System voltage MAX	03 / 04		020C	2	mV	120C	2	V
A1 _{MAX} • Phase 1 current MAX	03 / 04		020E	2	mA	120E	2	A
A2 _{MAX} • Phase 2 current MAX	03 / 04		0210	2	mA	1210	2	A
A3 _{MAX} • Phase 3 current MAX	03 / 04		0212	2	mA	1212	2	A
AN _{MAX} • Neutral current MAX*	03 / 04		0214	2	mA	1214	2	A
A _{ΣMAX} • System current MAX	03 / 04		0216	2	mA	1216	2	A
+P1 _{MAX} • Phase 1 imported active power MAX	03 / 04		0218	4	mW	1218	2	W
-P1 _{MAX} • Phase 1 exported active power MAX	03 / 04		021C	4	mW	121A	2	W
+P2 _{MAX} • Phase 2 imported active power MAX	03 / 04		0220	4	mW	121C	2	W
-P2 _{MAX} • Phase 2 exported active power MAX	03 / 04		0224	4	mW	121E	2	W
+P3 _{MAX} • Phase 3 imported active power MAX	03 / 04		0228	4	mW	1220	2	W
-P3 _{MAX} • Phase 3 exported active power MAX	03 / 04		022C	4	mW	1222	2	W
+P _{ΣMAX} • System imported active power MAX	03 / 04		0230	4	mW	1224	2	W
-P _{ΣMAX} • System exported active power MAX	03 / 04		0234	4	mW	1226	2	W
+S1 _{MAX} • Phase 1 imported apparent power MAX	03 / 04		0238	4	mVA	1228	2	VA
-S1 _{MAX} • Phase 1 exported apparent power MAX	03 / 04		023C	4	mVA	122A	2	VA
+S2 _{MAX} • Phase 2 imported apparent power MAX	03 / 04		0240	4	mVA	122C	2	VA
-S2 _{MAX} • Phase 2 exported apparent power MAX	03 / 04		0244	4	mVA	122E	2	VA
+S3 _{MAX} • Phase 3 imported apparent power MAX	03 / 04		0248	4	mVA	1230	2	VA
-S3 _{MAX} • Phase 3 exported apparent power MAX	03 / 04		024C	4	mVA	1232	2	VA
+S _{ΣMAX} • System imported apparent power MAX	03 / 04		0250	4	mVA	1234	2	VA
-S _{ΣMAX} • System exported apparent power MAX	03 / 04		0254	4	mVA	1236	2	VA
+Q1 _{MAX} • Phase 1 imported reactive power MAX	03 / 04		0258	4	mvar	1238	2	var
-Q1 _{MAX} • Phase 1 exported reactive power MAX	03 / 04		025C	4	mvar	123A	2	var
+Q2 _{MAX} • Phase 2 imported reactive power MAX	03 / 04		0260	4	mvar	123C	2	var
-Q2 _{MAX} • Phase 2 exported reactive power MAX	03 / 04		0264	4	mvar	123E	2	var
+Q3 _{MAX} • Phase 3 imported reactive power MAX	03 / 04		0268	4	mvar	1240	2	var
-Q3 _{MAX} • Phase 3 exported reactive power MAX	03 / 04		026C	4	mvar	1242	2	var
+Q _{ΣMAX} • System imported reactive power MAX	03 / 04		0270	4	mvar	1244	2	var
-Q _{ΣMAX} • System exported reactive power MAX	03 / 04		0274	4	mvar	1246	2	var
+PF1 _{MAX} • Phase 1 inductive power factor MAX	03 / 04		0278	2	0,001	1248	2	-
-PF1 _{MAX} • Phase 1 capacitive power factor MAX	03 / 04		027A	2	0,001	124A	2	-
+PF2 _{MAX} • Phase 2 inductive power factor MAX	03 / 04		027C	2	0,001	124C	2	-
-PF2 _{MAX} • Phase 2 capacitive power factor MAX	03 / 04		027E	2	0,001	124E	2	-
+PF3 _{MAX} • Phase 3 inductive power factor MAX	03 / 04		0280	2	0,001	1250	2	-
-PF3 _{MAX} • Phase 3 capacitive power factor MAX	03 / 04		0282	2	0,001	1252	2	-
+PF _{ΣMAX} • System inductive power factor MAX	03 / 04		0284	2	0,001	1254	2	-
-PF _{ΣMAX} • System capacitive power factor MAX	03 / 04		0286	2	0,001	1256	2	-

■ Available only for ENH instrument version.

* The neutral current and the derivative parameters (AN, THDAN, HaAN) are not available if the set CT ratio or FSA value is different for each phase.

Parameter	F. code (Hex)	Sign	INTEGER			IEEE		
			Register (Hex)	Words	M.U.	Register (Hex)	Words	M.U.
MAXIMUM VALUES								
+TAN \emptyset 1 _{MAX} • Phase 1 imported tangent \emptyset MAX	03 / 04		0288	2	0,001	1258	2	-
-TAN \emptyset 1 _{MAX} • Phase 1 exported tangent \emptyset MAX	03 / 04		028A	2	0,001	125A	2	-
+TAN \emptyset 2 _{MAX} • Phase 2 imported tangent \emptyset MAX	03 / 04		028C	2	0,001	125C	2	-
-TAN \emptyset 2 _{MAX} • Phase 2 exported tangent \emptyset MAX	03 / 04		028E	2	0,001	125E	2	-
+TAN \emptyset 3 _{MAX} • Phase 3 imported tangent \emptyset MAX	03 / 04		0290	2	0,001	1260	2	-
-TAN \emptyset 3 _{MAX} • Phase 3 exported tangent \emptyset MAX	03 / 04		0292	2	0,001	1262	2	-
+TAN \emptyset Σ _{MAX} • System imported tangent \emptyset MAX	03 / 04		0294	2	0,001	1264	2	-
-TAN \emptyset Σ _{MAX} • System exported tangent \emptyset MAX	03 / 04		0296	2	0,001	1266	2	-
THDV1 _{MAX} • Phase 1-N voltage THD MAX	03 / 04		0298	2	m%	1268	2	%
THDV2 _{MAX} • Phase 2-N voltage THD MAX	03 / 04		029A	2	m%	126A	2	%
THDV3 _{MAX} • Phase 3-N voltage THD MAX	03 / 04		029C	2	m%	126C	2	%
THDV12 _{MAX} • Line 12 voltage THD MAX	03 / 04		029E	2	m%	126E	2	%
THDV23 _{MAX} • Line 23 voltage THD MAX	03 / 04		02A0	2	m%	1270	2	%
THDV31 _{MAX} • Line 31 voltage THD MAX	03 / 04		02A2	2	m%	1272	2	%
THDA1 _{MAX} • Phase 1 current THD MAX	03 / 04		02A4	2	m%	1274	2	%
THDA2 _{MAX} • Phase 2 current THD MAX	03 / 04		02A6	2	m%	1276	2	%
THDA3 _{MAX} • Phase 3 current THD MAX	03 / 04		02A8	2	m%	1278	2	%
THDAN _{MAX} • Neutral current THD MAX*	03 / 04		02AA	2	m%	127A	2	%
A1 _{DMDMAX} • Phase 1 current DMD MAX	03 / 04		02AC	2	mA	127C	2	A
A2 _{DMDMAX} • Phase 2 current DMD MAX	03 / 04		02AE	2	mA	127E	2	A
A3 _{DMDMAX} • Phase 3 current DMD MAX	03 / 04		02B0	2	mA	1280	2	A
A Σ _{DMDMAX} • System current DMD MAX	03 / 04		02B2	2	mA	1282	2	A
+P1 _{DMDMAX} • Phase 1 imported active power DMD MAX	03 / 04		02B4	4	mW	1284	2	W
-P1 _{DMDMAX} • Phase 1 exported active power DMD MAX	03 / 04		02B8	4	mW	1286	2	W
+P2 _{DMDMAX} • Phase 2 imported active power DMD MAX	03 / 04		02BC	4	mW	1288	2	W
-P2 _{DMDMAX} • Phase 2 exported active power DMD MAX	03 / 04		02C0	4	mW	128A	2	W
+P3 _{DMDMAX} • Phase 3 imported active power DMD MAX	03 / 04		02C4	4	mW	128C	2	W
-P3 _{DMDMAX} • Phase 3 exported active power DMD MAX	03 / 04		02C8	4	mW	128E	2	W
+P Σ _{DMDMAX} • System imported active power DMD MAX	03 / 04		02CC	4	mW	1290	2	W
-P Σ _{DMDMAX} • System exported active power DMD MAX	03 / 04		02D0	4	mW	1292	2	W
+S1 _{DMDMAX} • Phase 1 imported apparent power DMD MAX	03 / 04		02D4	4	mVA	1294	2	VA
-S1 _{DMDMAX} • Phase 1 exported apparent power DMD MAX	03 / 04		02D8	4	mVA	1296	2	VA
+S2 _{DMDMAX} • Phase 2 imported apparent power DMD MAX	03 / 04		02DC	4	mVA	1298	2	VA
-S2 _{DMDMAX} • Phase 2 exported apparent power DMD MAX	03 / 04		02E0	4	mVA	129A	2	VA
+S3 _{DMDMAX} • Phase 3 imported apparent power DMD MAX	03 / 04		02E4	4	mVA	129C	2	VA
-S3 _{DMDMAX} • Phase 3 exported apparent power DMD MAX	03 / 04		02E8	4	mVA	129E	2	VA
+S Σ _{DMDMAX} • System imported apparent power DMD MAX	03 / 04		02EC	4	mVA	12A0	2	VA
-S Σ _{DMDMAX} • System exported apparent power DMD MAX	03 / 04		02F0	4	mVA	12A2	2	VA
+Q1 _{DMDMAX} • Phase 1 imported reactive power DMD MAX	03 / 04		02F4	4	mvar	12A4	2	var
-Q1 _{DMDMAX} • Phase 1 exported reactive power DMD MAX	03 / 04		02F8	4	mvar	12A6	2	var
+Q2 _{DMDMAX} • Phase 2 imported reactive power DMD MAX	03 / 04		02FC	4	mvar	12A8	2	var
-Q2 _{DMDMAX} • Phase 2 exported reactive power DMD MAX	03 / 04		0300	4	mvar	12AA	2	var
+Q3 _{DMDMAX} • Phase 3 imported reactive power DMD MAX	03 / 04		0304	4	mvar	12AC	2	var
-Q3 _{DMDMAX} • Phase 3 exported reactive power DMD MAX	03 / 04		0308	4	mvar	12AE	2	var
+Q Σ _{DMDMAX} • System imported reactive power DMD MAX	03 / 04		030C	4	mvar	12B0	2	var
-Q Σ _{DMDMAX} • System exported reactive power DMD MAX	03 / 04		0310	4	mvar	12B2	2	var

■ Available only for ENH instrument version.

* The neutral current and the derivative parameters (AN, THDAN, HaAN) are not available if the set CT ratio or FSA value is different for each phase.

Parameter	F. code (Hex)	Sign	INTEGER			IEEE		
			Register (Hex)	Words	M.U.	Register (Hex)	Words	M.U.
MINIMUM VALUES								
$P_{\Sigma_{MIN}}$ • System active power MIN	03 / 04		0314	4	mW	12B4	2	W
$S_{\Sigma_{MIN}}$ • System apparent power MIN	03 / 04		0318	4	mVA	12B6	2	VA
$Q_{\Sigma_{MIN}}$ • System reactive power MIN	03 / 04		031C	4	mvar	12B8	2	var
ENERGY COUNTERS								
+kWh1 • Phase 1 imported active energy	03 / 04		0400	4	0,1Wh	1400	2	Wh
-kWh1 • Phase 1 exported active energy	03 / 04		0404	4	0,1Wh	1402	2	Wh
+kWh2 • Phase 2 imported active energy	03 / 04		0408	4	0,1Wh	1404	2	Wh
-kWh2 • Phase 2 exported active energy	03 / 04		040C	4	0,1Wh	1406	2	Wh
+kWh3 • Phase 3 imported active energy	03 / 04		0410	4	0,1Wh	1408	2	Wh
-kWh3 • Phase 3 exported active energy	03 / 04		0414	4	0,1Wh	140A	2	Wh
+kWh Σ • System imported active energy	03 / 04		0418	4	0,1Wh	140C	2	Wh
-kWh Σ • System exported active energy	03 / 04		041C	4	0,1Wh	140E	2	Wh
kWh Σ BAL • Balance of system active energy (imp-exp)	03 / 04		0420	4	0,1Wh	1410	2	Wh
+kVAh1-C • Phase 1 imported capacitive apparent energy	03 / 04		0424	4	0,1VAh	1412	2	VAh
-kVAh1-C • Phase 1 exported capacitive apparent energy	03 / 04		0428	4	0,1VAh	1414	2	VAh
+kVAh1-L • Phase 1 imported inductive apparent energy	03 / 04		042C	4	0,1VAh	1416	2	VAh
-kVAh1-L • Phase 1 exported inductive apparent energy	03 / 04		0430	4	0,1VAh	1418	2	VAh
+kVAh1 • Phase 1 imported apparent energy	03 / 04		0434	4	0,1VAh	141A	2	VAh
-kVAh1 • Phase 1 exported apparent energy	03 / 04		0438	4	0,1VAh	141C	2	VAh
+kVAh2-C • Phase 2 imported capacitive apparent energy	03 / 04		043C	4	0,1VAh	141E	2	VAh
-kVAh2-C • Phase 2 exported capacitive apparent energy	03 / 04		0440	4	0,1VAh	1420	2	VAh
+kVAh2-L • Phase 2 imported inductive apparent energy	03 / 04		0444	4	0,1VAh	1422	2	VAh
-kVAh2-L • Phase 2 exported inductive apparent energy	03 / 04		0448	4	0,1VAh	1424	2	VAh
+kVAh2 • Phase 2 imported apparent energy	03 / 04		044C	4	0,1VAh	1426	2	VAh
-kVAh2 • Phase 2 exported apparent energy	03 / 04		0450	4	0,1VAh	1428	2	VAh
+kVAh3-C • Phase 3 imported capacitive apparent energy	03 / 04		0454	4	0,1VAh	142A	2	VAh
-kVAh3-C • Phase 3 exported capacitive apparent energy	03 / 04		0458	4	0,1VAh	142C	2	VAh
+kVAh3-L • Phase 3 imported inductive apparent energy	03 / 04		045C	4	0,1VAh	142E	2	VAh
-kVAh3-L • Phase 3 exported inductive apparent energy	03 / 04		0460	4	0,1VAh	1430	2	VAh
+kVAh3 • Phase 3 imported apparent energy	03 / 04		0464	4	0,1VAh	1432	2	VAh
-kVAh3 • Phase 3 exported apparent energy	03 / 04		0468	4	0,1VAh	1434	2	VAh
+kVAh Σ -C • System imported capacitive apparent energy	03 / 04		046C	4	0,1VAh	1436	2	VAh
-kVAh Σ -C • System exported capacitive apparent energy	03 / 04		0470	4	0,1VAh	1438	2	VAh
+kVAh Σ -L • System imported inductive apparent energy	03 / 04		0474	4	0,1VAh	143A	2	VAh
-kVAh Σ -L • System exported inductive apparent energy	03 / 04		0478	4	0,1VAh	143C	2	VAh
+kVAh Σ • System imported apparent energy	03 / 04		047C	4	0,1VAh	143E	2	VAh
-kVAh Σ • System exported apparent energy	03 / 04		0480	4	0,1VAh	1440	2	VAh
kVAh Σ BAL-C • Balance of system capacitive apparent en. (imp-exp)	03 / 04		0484	4	0,1VAh	1442	2	VAh
kVAh Σ BAL-L • Balance of system inductive apparent en. (imp-exp)	03 / 04		0488	4	0,1VAh	1444	2	VAh
kVAh Σ BAL • Balance of system apparent energy (BAL-C + BAL-L)	03 / 04		048C	4	0,1VAh	1446	2	VAh
+kvarh1-C • Phase 1 imported capacitive reactive energy	03 / 04		0490	4	0,1varh	1448	2	varh
-kvarh1-C • Phase 1 exported capacitive reactive energy	03 / 04		0494	4	0,1varh	144A	2	varh
+kvarh1-L • Phase 1 imported inductive reactive energy	03 / 04		0498	4	0,1varh	144C	2	varh
-kvarh1-L • Phase 1 exported inductive reactive energy	03 / 04		049C	4	0,1varh	144E	2	varh

■ Available only for instrument with separated Inductive and Capacitive apparent counters.

■ Available only for instrument with Total apparent counters (ind+cap).

Parameter	F. code (Hex)	Sign	INTEGER			IEEE		
			Register (Hex)	Words	M.U.	Register (Hex)	Words	M.U.
ENERGY COUNTERS								
+kvarh2-C • Phase 2 imported capacitive reactive energy	03 / 04		04A0	4	0,1varh	1450	2	varh
-kvarh2-C • Phase 2 exported capacitive reactive energy	03 / 04		04A4	4	0,1varh	1452	2	varh
+kvarh2-L • Phase 2 imported inductive reactive energy	03 / 04		04A8	4	0,1varh	1454	2	varh
-kvarh2-L • Phase 2 exported inductive reactive energy	03 / 04		04AC	4	0,1varh	1456	2	varh
+kvarh3-C • Phase 3 imported capacitive reactive energy	03 / 04		04B0	4	0,1varh	1458	2	varh
-kvarh3-C • Phase 3 exported capacitive reactive energy	03 / 04		04B4	4	0,1varh	145A	2	varh
+kvarh3-L • Phase 3 imported inductive reactive energy	03 / 04		04B8	4	0,1varh	145C	2	varh
-kvarh3-L • Phase 3 exported inductive reactive energy	03 / 04		04BC	4	0,1varh	145E	2	varh
+kvarhΣ-C • System imported capacitive reactive energy	03 / 04		04C0	4	0,1varh	1460	2	varh
-kvarhΣ-C • System exported capacitive reactive energy	03 / 04		04C4	4	0,1varh	1462	2	varh
+kvarhΣ-L • System imported inductive reactive energy	03 / 04		04C8	4	0,1varh	1464	2	varh
-kvarhΣ-L • System exported inductive reactive energy	03 / 04		04CC	4	0,1varh	1466	2	varh
kvarhΣBAL-C • Balance of system capacitive reactive en. (imp-exp)	03 / 04		04D0	4	0,1varh	1468	2	varh
kvarhΣBAL-L • Balance of system inductive reactive en. (imp-exp)	03 / 04		04D4	4	0,1varh	146A	2	varh
kvarhΣBAL • Balance of system reactive energy (BAL-C + BAL-L)	03 / 04		04D8	4	0,1varh	146C	2	varh
VOLTAGE & CURRENT HARMONIC COMPONENT UP TO 15th								
HaV1 • Phase 1-N voltage component 0 (DC)	03 / 04		0500	2	0,01%	1500	2	%
HaV1 • Phase 1-N voltage component 1 st	03 / 04		0502	2	0,01%	1502	2	%
HaV1 • Phase 1-N voltage component 2 nd	03 / 04		0504	2	0,01%	1504	2	%
HaV1 • Phase 1-N voltage component 3 rd	03 / 04		0506	2	0,01%	1506	2	%
HaV1 • Phase 1-N voltage component 4 th	03 / 04		0508	2	0,01%	1508	2	%
HaV1 • Phase 1-N voltage component 5 th	03 / 04		050A	2	0,01%	150A	2	%
HaV1 • Phase 1-N voltage component 6 th	03 / 04		050C	2	0,01%	150C	2	%
HaV1 • Phase 1-N voltage component 7 th	03 / 04		050E	2	0,01%	150E	2	%
HaV1 • Phase 1-N voltage component 8 th	03 / 04		0510	2	0,01%	1510	2	%
HaV1 • Phase 1-N voltage component 9 th	03 / 04		0512	2	0,01%	1512	2	%
HaV1 • Phase 1-N voltage component 10 th	03 / 04		0514	2	0,01%	1514	2	%
HaV1 • Phase 1-N voltage component 11 th	03 / 04		0516	2	0,01%	1516	2	%
HaV1 • Phase 1-N voltage component 12 th	03 / 04		0518	2	0,01%	1518	2	%
HaV1 • Phase 1-N voltage component 13 th	03 / 04		051A	2	0,01%	151A	2	%
HaV1 • Phase 1-N voltage component 14 th	03 / 04		051C	2	0,01%	151C	2	%
HaV1 • Phase 1-N voltage component 15 th	03 / 04		051E	2	0,01%	151E	2	%
HaV2 • Phase 2-N voltage component 0 (DC)	03 / 04		0520	2	0,01%	1520	2	%
HaV2 • Phase 2-N voltage component 1 st	03 / 04		0522	2	0,01%	1522	2	%
HaV2 • Phase 2-N voltage component 2 nd	03 / 04		0524	2	0,01%	1524	2	%
HaV2 • Phase 2-N voltage component 3 rd	03 / 04		0526	2	0,01%	1526	2	%
HaV2 • Phase 2-N voltage component 4 th	03 / 04		0528	2	0,01%	1528	2	%
HaV2 • Phase 2-N voltage component 5 th	03 / 04		052A	2	0,01%	152A	2	%
HaV2 • Phase 2-N voltage component 6 th	03 / 04		052C	2	0,01%	152C	2	%
HaV2 • Phase 2-N voltage component 7 th	03 / 04		052E	2	0,01%	152E	2	%
HaV2 • Phase 2-N voltage component 8 th	03 / 04		0530	2	0,01%	1530	2	%
HaV2 • Phase 2-N voltage component 9 th	03 / 04		0532	2	0,01%	1532	2	%
HaV2 • Phase 2-N voltage component 10 th	03 / 04		0534	2	0,01%	1534	2	%
HaV2 • Phase 2-N voltage component 11 th	03 / 04		0536	2	0,01%	1536	2	%
HaV2 • Phase 2-N voltage component 12 th	03 / 04		0538	2	0,01%	1538	2	%

■ Available only for ENH instrument version.

Parameter	F. code (Hex)	Sign	INTEGER			IEEE		
			Register (Hex)	Words	M.U.	Register (Hex)	Words	M.U.
VOLTAGE & CURRENT HARMONIC COMPONENT UP TO 15th								
HaV2 • Phase 2-N voltage component 13 th	03 / 04		053A	2	0,01%	153A	2	%
HaV2 • Phase 2-N voltage component 14 th	03 / 04		053C	2	0,01%	153C	2	%
HaV2 • Phase 2-N voltage component 15 th	03 / 04		053E	2	0,01%	153E	2	%
HaV3 • Phase 3-N voltage component 0 (DC)	03 / 04		0540	2	0,01%	1540	2	%
HaV3 • Phase 3-N voltage component 1 st	03 / 04		0542	2	0,01%	1542	2	%
HaV3 • Phase 3-N voltage component 2 nd	03 / 04		0544	2	0,01%	1544	2	%
HaV3 • Phase 3-N voltage component 3 rd	03 / 04		0546	2	0,01%	1546	2	%
HaV3 • Phase 3-N voltage component 4 th	03 / 04		0548	2	0,01%	1548	2	%
HaV3 • Phase 3-N voltage component 5 th	03 / 04		054A	2	0,01%	154A	2	%
HaV3 • Phase 3-N voltage component 6 th	03 / 04		054C	2	0,01%	154C	2	%
HaV3 • Phase 3-N voltage component 7 th	03 / 04		054E	2	0,01%	154E	2	%
HaV3 • Phase 3-N voltage component 8 th	03 / 04		0550	2	0,01%	1550	2	%
HaV3 • Phase 3-N voltage component 9 th	03 / 04		0552	2	0,01%	1552	2	%
HaV3 • Phase 3-N voltage component 10 th	03 / 04		0554	2	0,01%	1554	2	%
HaV3 • Phase 3-N voltage component 11 th	03 / 04		0556	2	0,01%	1556	2	%
HaV3 • Phase 3-N voltage component 12 th	03 / 04		0558	2	0,01%	1558	2	%
HaV3 • Phase 3-N voltage component 13 th	03 / 04		055A	2	0,01%	155A	2	%
HaV3 • Phase 3-N voltage component 14 th	03 / 04		055C	2	0,01%	155C	2	%
HaV3 • Phase 3-N voltage component 15 th	03 / 04		055E	2	0,01%	155E	2	%
HaV12 • Line 12 voltage component 0 (DC)	03 / 04		0560	2	0,01%	1560	2	%
HaV12 • Line 12 voltage component 1 st	03 / 04		0562	2	0,01%	1562	2	%
HaV12 • Line 12 voltage component 2 nd	03 / 04		0564	2	0,01%	1564	2	%
HaV12 • Line 12 voltage component 3 rd	03 / 04		0566	2	0,01%	1566	2	%
HaV12 • Line 12 voltage component 4 th	03 / 04		0568	2	0,01%	1568	2	%
HaV12 • Line 12 voltage component 5 th	03 / 04		056A	2	0,01%	156A	2	%
HaV12 • Line 12 voltage component 6 th	03 / 04		056C	2	0,01%	156C	2	%
HaV12 • Line 12 voltage component 7 th	03 / 04		056E	2	0,01%	156E	2	%
HaV12 • Line 12 voltage component 8 th	03 / 04		0570	2	0,01%	1570	2	%
HaV12 • Line 12 voltage component 9 th	03 / 04		0572	2	0,01%	1572	2	%
HaV12 • Line 12 voltage component 10 th	03 / 04		0574	2	0,01%	1574	2	%
HaV12 • Line 12 voltage component 11 th	03 / 04		0576	2	0,01%	1576	2	%
HaV12 • Line 12 voltage component 12 th	03 / 04		0578	2	0,01%	1578	2	%
HaV12 • Line 12 voltage component 13 th	03 / 04		057A	2	0,01%	157A	2	%
HaV12 • Line 12 voltage component 14 th	03 / 04		057C	2	0,01%	157C	2	%
HaV12 • Line 12 voltage component 15 th	03 / 04		057E	2	0,01%	157E	2	%
HaV23 • Line 23 voltage component 0 (DC)	03 / 04		0580	2	0,01%	1580	2	%
HaV23 • Line 23 voltage component 1 st	03 / 04		0582	2	0,01%	1582	2	%
HaV23 • Line 23 voltage component 2 nd	03 / 04		0584	2	0,01%	1584	2	%
HaV23 • Line 23 voltage component 3 rd	03 / 04		0586	2	0,01%	1586	2	%
HaV23 • Line 23 voltage component 4 th	03 / 04		0588	2	0,01%	1588	2	%
HaV23 • Line 23 voltage component 5 th	03 / 04		058A	2	0,01%	158A	2	%
HaV23 • Line 23 voltage component 6 th	03 / 04		058C	2	0,01%	158C	2	%
HaV23 • Line 23 voltage component 7 th	03 / 04		058E	2	0,01%	158E	2	%
HaV23 • Line 23 voltage component 8 th	03 / 04		0590	2	0,01%	1590	2	%
HaV23 • Line 23 voltage component 9 th	03 / 04		0592	2	0,01%	1592	2	%

■ Available only for ENH instrument version.

Parameter	F. code (Hex)	Sign	INTEGER			IEEE		
			Register (Hex)	Words	M.U.	Register (Hex)	Words	M.U.
VOLTAGE & CURRENT HARMONIC COMPONENT UP TO 15th								
HaV23 • Line 23 voltage component 10 th	03 / 04		0594	2	0,01%	1594	2	%
HaV23 • Line 23 voltage component 11 th	03 / 04		0596	2	0,01%	1596	2	%
HaV23 • Line 23 voltage component 12 th	03 / 04		0598	2	0,01%	1598	2	%
HaV23 • Line 23 voltage component 13 th	03 / 04		059A	2	0,01%	159A	2	%
HaV23 • Line 23 voltage component 14 th	03 / 04		059C	2	0,01%	159C	2	%
HaV23 • Line 23 voltage component 15 th	03 / 04		059E	2	0,01%	159E	2	%
HaV31 • Line 31 voltage component 0 (DC)	03 / 04		05A0	2	0,01%	15A0	2	%
HaV31 • Line 31 voltage component 1 st	03 / 04		05A2	2	0,01%	15A2	2	%
HaV31 • Line 31 voltage component 2 nd	03 / 04		05A4	2	0,01%	15A4	2	%
HaV31 • Line 31 voltage component 3 rd	03 / 04		05A6	2	0,01%	15A6	2	%
HaV31 • Line 31 voltage component 4 th	03 / 04		05A8	2	0,01%	15A8	2	%
HaV31 • Line 31 voltage component 5 th	03 / 04		05AA	2	0,01%	15AA	2	%
HaV31 • Line 31 voltage component 6 th	03 / 04		05AC	2	0,01%	15AC	2	%
HaV31 • Line 31 voltage component 7 th	03 / 04		05AE	2	0,01%	15AE	2	%
HaV31 • Line 31 voltage component 8 th	03 / 04		05B0	2	0,01%	15B0	2	%
HaV31 • Line 31 voltage component 9 th	03 / 04		05B2	2	0,01%	15B2	2	%
HaV31 • Line 31 voltage component 10 th	03 / 04		05B4	2	0,01%	15B4	2	%
HaV31 • Line 31 voltage component 11 th	03 / 04		05B6	2	0,01%	15B6	2	%
HaV31 • Line 31 voltage component 12 th	03 / 04		05B8	2	0,01%	15B8	2	%
HaV31 • Line 31 voltage component 13 th	03 / 04		05BA	2	0,01%	15BA	2	%
HaV31 • Line 31 voltage component 14 th	03 / 04		05BC	2	0,01%	15BC	2	%
HaV31 • Line 31 voltage component 15 th	03 / 04		05BE	2	0,01%	15BE	2	%
HaA1 • Phase 1 current component 0 (DC)	03 / 04		05C0	2	0,01%	15C0	2	%
HaA1 • Phase 1 current component 1 st	03 / 04		05C2	2	0,01%	15C2	2	%
HaA1 • Phase 1 current component 2 nd	03 / 04		05C4	2	0,01%	15C4	2	%
HaA1 • Phase 1 current component 3 rd	03 / 04		05C6	2	0,01%	15C6	2	%
HaA1 • Phase 1 current component 4 th	03 / 04		05C8	2	0,01%	15C8	2	%
HaA1 • Phase 1 current component 5 th	03 / 04		05CA	2	0,01%	15CA	2	%
HaA1 • Phase 1 current component 6 th	03 / 04		05CC	2	0,01%	15CC	2	%
HaA1 • Phase 1 current component 7 th	03 / 04		05CE	2	0,01%	15CE	2	%
HaA1 • Phase 1 current component 8 th	03 / 04		05D0	2	0,01%	15D0	2	%
HaA1 • Phase 1 current component 9 th	03 / 04		05D2	2	0,01%	15D2	2	%
HaA1 • Phase 1 current component 10 th	03 / 04		05D4	2	0,01%	15D4	2	%
HaA1 • Phase 1 current component 11 th	03 / 04		05D6	2	0,01%	15D6	2	%
HaA1 • Phase 1 current component 12 th	03 / 04		05D8	2	0,01%	15D8	2	%
HaA1 • Phase 1 current component 13 th	03 / 04		05DA	2	0,01%	15DA	2	%
HaA1 • Phase 1 current component 14 th	03 / 04		05DC	2	0,01%	15DC	2	%
HaA1 • Phase 1 current component 15 th	03 / 04		05DE	2	0,01%	15DE	2	%
HaA2 • Phase 2 current component 0 (DC)	03 / 04		05E0	2	0,01%	15E0	2	%
HaA2 • Phase 2 current component 1 st	03 / 04		05E2	2	0,01%	15E2	2	%
HaA2 • Phase 2 current component 2 nd	03 / 04		05E4	2	0,01%	15E4	2	%
HaA2 • Phase 2 current component 3 rd	03 / 04		05E6	2	0,01%	15E6	2	%
HaA2 • Phase 2 current component 4 th	03 / 04		05E8	2	0,01%	15E8	2	%
HaA2 • Phase 2 current component 5 th	03 / 04		05EA	2	0,01%	15EA	2	%
HaA2 • Phase 2 current component 6 th	03 / 04		05EC	2	0,01%	15EC	2	%

■ Available only for ENH instrument version.

Parameter	F. code (Hex)	Sign	INTEGER			IEEE		
			Register (Hex)	Words	M.U.	Register (Hex)	Words	M.U.
VOLTAGE & CURRENT HARMONIC COMPONENT UP TO 15th								
HaA2 • Phase 2 current component 7 th	03 / 04		05EE	2	0,01%	15EE	2	%
HaA2 • Phase 2 current component 8 th	03 / 04		05F0	2	0,01%	15F0	2	%
HaA2 • Phase 2 current component 9 th	03 / 04		05F2	2	0,01%	15F2	2	%
HaA2 • Phase 2 current component 10 th	03 / 04		05F4	2	0,01%	15F4	2	%
HaA2 • Phase 2 current component 11 th	03 / 04		05F6	2	0,01%	15F6	2	%
HaA2 • Phase 2 current component 12 th	03 / 04		05F8	2	0,01%	15F8	2	%
HaA2 • Phase 2 current component 13 th	03 / 04		05FA	2	0,01%	15FA	2	%
HaA2 • Phase 2 current component 14 th	03 / 04		05FC	2	0,01%	15FC	2	%
HaA2 • Phase 2 current component 15 th	03 / 04		05FE	2	0,01%	15FE	2	%
HaA3 • Phase 3 current component 0 (DC)	03 / 04		0600	2	0,01%	1600	2	%
HaA3 • Phase 3 current component 1 st	03 / 04		0602	2	0,01%	1602	2	%
HaA3 • Phase 3 current component 2 nd	03 / 04		0604	2	0,01%	1604	2	%
HaA3 • Phase 3 current component 3 rd	03 / 04		0606	2	0,01%	1606	2	%
HaA3 • Phase 3 current component 4 th	03 / 04		0608	2	0,01%	1608	2	%
HaA3 • Phase 3 current component 5 th	03 / 04		060A	2	0,01%	160A	2	%
HaA3 • Phase 3 current component 6 th	03 / 04		060C	2	0,01%	160C	2	%
HaA3 • Phase 3 current component 7 th	03 / 04		060E	2	0,01%	160E	2	%
HaA3 • Phase 3 current component 8 th	03 / 04		0610	2	0,01%	1610	2	%
HaA3 • Phase 3 current component 9 th	03 / 04		0612	2	0,01%	1612	2	%
HaA3 • Phase 3 current component 10 th	03 / 04		0614	2	0,01%	1614	2	%
HaA3 • Phase 3 current component 11 th	03 / 04		0616	2	0,01%	1616	2	%
HaA3 • Phase 3 current component 12 th	03 / 04		0618	2	0,01%	1618	2	%
HaA3 • Phase 3 current component 13 th	03 / 04		061A	2	0,01%	161A	2	%
HaA3 • Phase 3 current component 14 th	03 / 04		061C	2	0,01%	161C	2	%
HaA3 • Phase 3 current component 15 th	03 / 04		061E	2	0,01%	161E	2	%
HaAN • Neutral current component 0 (DC) *	03 / 04		0620	2	0,01%	1620	2	%
HaAN • Neutral current component 1 st *	03 / 04		0622	2	0,01%	1622	2	%
HaAN • Neutral current component 2 nd *	03 / 04		0624	2	0,01%	1624	2	%
HaAN • Neutral current component 3 rd *	03 / 04		0626	2	0,01%	1626	2	%
HaAN • Neutral current component 4 th *	03 / 04		0628	2	0,01%	1628	2	%
HaAN • Neutral current component 5 th *	03 / 04		062A	2	0,01%	162A	2	%
HaAN • Neutral current component 6 th *	03 / 04		062C	2	0,01%	162C	2	%
HaAN • Neutral current component 7 th *	03 / 04		062E	2	0,01%	162E	2	%
HaAN • Neutral current component 8 th *	03 / 04		0630	2	0,01%	1630	2	%
HaAN • Neutral current component 9 th *	03 / 04		0632	2	0,01%	1632	2	%
HaAN • Neutral current component 10 th *	03 / 04		0634	2	0,01%	1634	2	%
HaAN • Neutral current component 11 th *	03 / 04		0636	2	0,01%	1636	2	%
HaAN • Neutral current component 12 th *	03 / 04		0638	2	0,01%	1638	2	%
HaAN • Neutral current component 13 th *	03 / 04		063A	2	0,01%	163A	2	%
HaAN • Neutral current component 14 th *	03 / 04		063C	2	0,01%	163C	2	%
HaAN • Neutral current component 15 th *	03 / 04		063E	2	0,01%	163E	2	%

■ Available only for ENH instrument version.

* The neutral current and the derivative parameters (AN, THDAN, HaAN) are not available if the set CT ratio or FSA value is different for each phase.

Register description	F. code (Hex)	INTEGER		Data meaning
		Register (Hex)	Words	
INSTRUMENT INFORMATION				
Serial number	03 / 04	2000	6	10 ASCII characters, \$00...\$FF
Firmware release	03 / 04	2006	2	Convert the read hexadecimal value in decimal format. e.g. \$64=100=rel. 1.00
Hardware version	03 / 04	2008	2	Convert the read hexadecimal value in decimal format. e.g. \$64=100=rev. 1.00
Model	03 / 04	200A	2	\$04=1/5A CT, BASIC \$06=Rogowski inputs, BASIC \$0A=1/5A CT, ENH \$0C=Rogowski inputs, ENH
COM features	03 / 04	200C	2	\$02=RS485 port (MODBUS RTU) \$03=ETHERNET port (HTTP, MODBUS TCP)
Reserved	03 / 04	200E	2	
Digital output number	03 / 04	2010	2	\$02=2
Digital input number	03 / 04	2012	2	\$01=1
Analog output number	03 / 04	2014	2	\$00=0 \$01=1
Calibration date	03 / 04	2016	2	UnixTime format. Convert the read hexadecimal value in decimal format. e.g. \$0837\$B4C0=1378684800 →09/09/13, 00:00:00
Reserved	03 / 04	2018	4	
Error code	03 / 04	201C	2	Bit encoding (0=disabled, 1=active): b1(LSb)=wrong phase sequence (132) b2=overflow parameter/s b3=date&time lost, recordings automatically disabled b4=unable to generate pulses on digital output enabled in pulse mode e.g. \$0000\$0006=0110 →overflow parameter/s and date&time lost occurred

4.2 READING AND WRITING REGISTERS (FUNCTION CODE \$03 / \$04 / \$10)



WARNING! If CT ratio, PT ratio, wiring mode or current full scale is modified, the instrument will:

- reset all MIN/MAX values, all DMD values, all energy counters
- set to the default settings digital output/s (disabled)
- set the default recording setup (disabled) and delete all recorded data

Register description	F. code (Hex)	INTEGER		Programmable data
		Register (Hex)	Words	
INSTRUMENT GENERAL SETUP				
MODBUS address	03 / 04 / 10	2026	2	\$01...\$F7 (1...247)
Communication speed	03 / 04 / 10	2028	2	\$01=300 bps \$02=600 bps \$03=1200 bps \$04=2400 bps \$05=4800 bps \$06=9600 bps \$07=19200 bps \$08=38400 bps \$09=57600 bps
MODBUS mode	03 / 04	202A	2	\$01=8N1 (RTU)
Phase 1 current full scale, according to the instrument: • For 1/5A CT: CT primary (CT1 _{pri}) • For Rogowski: Full scale (FSA1)	03 / 04 / 10	202C	2	Ph1 CT primary: \$01...\$C350 (1...50000) FSA1: \$01F4=500 A \$0FA0=4000 A \$4E20=20000 A
Phase 1 CT secondary (only for 1/5 CT instrument)	03 / 04 / 10	202E	2	\$01=1 A \$05=5 A
Phase 2 current full scale, according to the instrument: • For 1/5A CT: CT primary (CT2 _{pri}) • For Rogowski: Full scale (FSA2)	03 / 04 / 10	2030	2	Ph2 CT primary: \$01...\$C350 (1...50000) FSA2: \$01F4=500 A \$0FA0=4000 A \$4E20=20000 A
Phase 2 CT secondary (only for 1/5 CT instrument)	03 / 04 / 10	2032	2	\$01=1 A \$05=5 A
Phase 3 current full scale, according to the instrument: • For 1/5A CT: CT primary (CT3 _{pri}) • For Rogowski: Full scale (FSA3)	03 / 04 / 10	2034	2	Ph3 CT primary: \$01...\$C350 (1...50000) FSA3: \$01F4=500 A \$0FA0=4000 A \$4E20=20000 A
Phase 3 CT secondary (only for 1/5 CT instrument)	03 / 04 / 10	2036	2	\$01=1 A \$05=5 A
PT primary	03 / 04 / 10	2038	2	\$00001...\$F423F (1...999999V) (for direct insertion, set PT _{pri} =1. PT _{sec} =1 will be set automatically)
PT secondary	03 / 04 / 10	203A	2	\$50...\$96 (80...150V) (if PT _{pri} =1 → PT _{sec} =1 automatically preset, not programmable)
Wiring mode	03 / 04 / 10	203C	2	\$01=3 phases, 4 wires, 3 currents \$02=3 phases, 3 wires, 2 currents \$03=1 phase \$04=3 phases, 3 wires, 3 currents
Mode for DMD value calculation	03 / 04 / 10	203E	2	\$00=fixed window \$01=sliding window \$02=fixed window with DI synchro
Integration time for DMD value calculation	03 / 04 / 10	2040	2	\$05=05 min \$0A=10 min \$0F=15 min \$1E=30 min \$2D=45 min (not available with Sliding window mode) \$3C=60 min (not available with Sliding window mode)

■ Available only for instrument with RS485 port.

■ Available only for ENH instrument version.

Register description	F. code (Hex)	INTEGER		Programmable data
		Register (Hex)	Words	
INSTRUMENT GENERAL SETUP				
Maximum and DMD max value reset	10	2042	2	\$01=V1, V2, V3, V12, V23, V31, V Σ \$02=A1, A2, A3, AN, A Σ \$03=+P1, +P2, +P3, +P Σ \$04=-P1, -P2, -P3, -P Σ \$05=+S1, +S2, +S3, +S Σ \$06=-S1, -S2, -S3, -S Σ \$07=+Q1, +Q2, +Q3, +Q Σ \$08=-Q1, -Q2, -Q3, -Q Σ \$09=+PF1, +PF2, +PF3, +PF Σ \$0A=-PF1, -PF2, -PF3, -PF Σ \$0B=+TAN1, +TAN2, +TAN3, +TAN Σ \$0C=-TAN1, -TAN2, -TAN3, -TAN Σ \$0D=THDV1, THDV2, THDV3, THDV12, THDV23, THDV31 \$0E=THDA1, THDA2, THDA3, THDAN \$0F=A1 _{DMD} , A2 _{DMD} , A3 _{DMD} , A Σ _{DMD} \$10=+P1 _{DMD} , +P2 _{DMD} , +P3 _{DMD} , +P Σ _{DMD} \$11=-P1 _{DMD} , -P2 _{DMD} , -P3 _{DMD} , -P Σ _{DMD} \$12=+S1 _{DMD} , +S2 _{DMD} , +S3 _{DMD} , +S Σ _{DMD} \$13=-S1 _{DMD} , -S2 _{DMD} , -S3 _{DMD} , -S Σ _{DMD} \$14=+Q1 _{DMD} , +Q2 _{DMD} , +Q3 _{DMD} , +Q Σ _{DMD} \$15=-Q1 _{DMD} , -Q2 _{DMD} , -Q3 _{DMD} , -Q Σ _{DMD} \$16=ALL
Minimum value reset	10	2044	2	\$01=P Σ \$02=S Σ \$03=Q Σ \$04=ALL
DMD value reset	10	2046	2	\$01=A1 _{DMD} , A2 _{DMD} , A3 _{DMD} , AN _{DMD} , A Σ _{DMD} \$02=+P1 _{DMD} , +P2 _{DMD} , +P3 _{DMD} , +P Σ _{DMD} \$03=-P1 _{DMD} , -P2 _{DMD} , -P3 _{DMD} , -P Σ _{DMD} \$04=+S1 _{DMD} , +S2 _{DMD} , +S3 _{DMD} , +S Σ _{DMD} \$05=-S1 _{DMD} , -S2 _{DMD} , -S3 _{DMD} , -S Σ _{DMD} \$06=+Q1 _{DMD} , +Q2 _{DMD} , +Q3 _{DMD} , +Q Σ _{DMD} \$07=-Q1 _{DMD} , -Q2 _{DMD} , -Q3 _{DMD} , -Q Σ _{DMD} \$08=+PF1 _{DMD} , +PF2 _{DMD} , +PF3 _{DMD} , +PF Σ _{DMD} \$09=-PF1 _{DMD} , -PF2 _{DMD} , -PF3 _{DMD} , -PF Σ _{DMD} \$0A=ALL
Energy counter reset	10	2048	2	\$01=+kWh1, +kWh2, +kWh3, +kWh Σ \$02=-kWh1, -kWh2, -kWh3, -kWh Σ \$03=+kVAh1, +kVAh2, +kVAh3, +kVAh Σ (L&C) \$04=-kVAh1, -kVAh2, -kVAh3, -kVAh Σ (L&C) \$05=+kvarh1, +kvarh2, +kvarh3, +kvarh Σ (L&C) \$06=-kvarh1, -kvarh2, -kvarh3, -kvarh Σ (L&C) \$07=ALL
Real time clock The writing command can be sent also in broadcast by using \$00 MODBUS address. For broadcast function, no instrument response is sent.	03 / 04 / 10	204A	2	UnixTime format. READING MODE - Convert the read hexadecimal value in decimal format. e.g. \$522E\$5FD4=1378770900 →09/09/13, 23:55:00 WRITING MODE - Convert the UnixTime decimal value in hexadecimal format. e.g. to set: 09/09/13, 23:55:00→1378770900= \$522E\$5FD4 value to be set

Register description	F. code (Hex)	INTEGER		Programmable data
		Register (Hex)	Words	
INSTRUMENT GENERAL SETUP				
Digital output 1 mode	03 / 04 / 10	204C	2	\$00=disabled \$01=alarm high or active power sign change from + to - \$02=alarm low or active power sign change from - to + \$03=pulse
Digital output 1 parameter	03 / 04 / 10	204E	2	Refer to the "Parameter codes" table
Digital output 1 setup according to the mode: • Alarm (AL): Threshold referred to the set parameter • Pulse (PULS): Pulse weight numerical value	03 / 04 / 10	2050	4	In Alarm mode: \$0001... full scale value of the set parameter. The measuring unit changes according to the set parameter. The value is always expressed with the milli (m) coefficient: e.g. \$38270=230000mV=230V For Phase sequence and Active power sign parameters, set \$0000. In Pulse mode: \$0001...\$270F (1...9999) e.g. \$0A00=2560=2.56 kWh / pulse with pulse value format X.XXX kWh, VAh, varh / pulse (value \$01 in register \$2054)
Digital output 1 setup according to the mode: • Alarm (AL): Hysteresis value in case of real time/DMD parameter, delay value in case of Active power sign parameter • Pulse (PULS): Pulse value format	03 / 04 / 10	2054	2	In Alarm mode: \$00...\$32 (0...50%) For Phase sequence parameter, set \$00. For Active power sign parameter: \$01...\$3C (1...60s) In Pulse mode: \$01=X.XXX kWh, VAh, varh / pulse \$02=XX.XX kWh, VAh, varh / pulse \$03=XXX.X kWh, VAh, varh / pulse \$04=X.XXX MWh, VAh, varh / pulse \$05=XX.XX MWh, VAh, varh / pulse \$06=XXX.X MWh, VAh, varh / pulse \$07=XXXX MWh, VAh, varh / pulse
Digital output 2 mode	03 / 04 / 10	2056	2	\$00=disabled \$01=alarm high or active power sign change from + to - \$02=alarm low or active power sign change from - to + \$03=pulse
Digital output 2 parameter	03 / 04 / 10	2058	2	Refer to the "Parameter codes" table
Digital output 2 setup according to the mode: • Alarm (AL): Threshold referred to the set parameter • Pulse (PULS): Pulse weight numerical value	03 / 04 / 10	205A	4	In Alarm mode: \$0001... full scale value of the set parameter. The measuring unit changes according to the set parameter. The value is always expressed with the milli (m) coefficient: e.g. \$38270=230000mV=230V For Phase sequence and Active power sign parameters, set \$0000. In Pulse mode: \$0001...\$270F (1...9999) e.g. \$0A00=2560=2.56 kWh / pulse with pulse value format X.XXX kWh, VAh, varh / pulse (value \$01 in register \$2054)

Register description	F. code (Hex)	INTEGER		Programmable data
		Register (Hex)	Words	
INSTRUMENT GENERAL SETUP				
Digital output 2 setup according to the mode: • Alarm (AL): Hysteresis value in case of real time/DMD parameter, delay value in case of Active power sign parameter • Pulse (PULS): Pulse value format	03 / 04 / 10	205E	2	In Alarm mode: \$00...\$32 (0...50%) For Phase sequence parameter, set \$00. For Active power sign parameter: \$01...\$3C (1...60s) In Pulse mode: \$01=X.XXX kWh, VAh, varh / pulse \$02=XX.XX kWh, VAh, varh / pulse \$03=XXX.X kWh, VAh, varh / pulse \$04=X.XXX MWh, VAh, varh / pulse \$05=XX.XX MWh, VAh, varh / pulse \$06=XXX.X MWh, VAh, varh / pulse \$07=XXXX MWh, VAh, varh / pulse
ETHERNET set default Restore the ETHERNET settings to the default values (IP, account username&password)	10	2074	2	\$AAAA\$AAAA=ETHERNET set default
Analog output mode and parameter	03 / 04 / 10	2082	2	Format: 0000 XXYY , where: XX=AO parameter YY=AO mode <u>AO parameter:</u> Refer to the "Parameter codes" table <u>AO mode values:</u> \$00=disabled \$01=0-20 mA \$02=4-20 mA e.g. \$0000\$0902=AO programmed with phase 2 current parameter (A2) and enabled in 4-20 mA mode
Analog output low threshold	03 / 04 / 10	2084	4	LOW full scale value of the set parameter, assigned to 0 or 4 mA. The measuring unit changes according to the set parameter.
Analog output high threshold	03 / 04 / 10	2088	4	HIGH full scale value of the set parameter, assigned to 20 mA. The measuring unit changes according to the set parameter.
Number of the stored AVG or MIN/AVG/MAX recordings (according to the instrument model)	03 / 04	2100	2	e.g. \$007F=127 recordings
Timestamp of the first AVG or MIN/AVG/MAX recording (according to the instrument model)	03 / 04	2102	2	UnixTime format. Convert the read hexadecimal value in decimal format. e.g. \$522E\$5FD4=1378770900 →09/09/13, 23:55:00
Timestamp of the last AVG or MIN/AVG/MAX recording (according to the instrument model)	03 / 04	2104	2	UnixTime format. Convert the read hexadecimal value in decimal format. e.g. \$522E\$5FD4=1378770900 →09/09/13, 23:55:00
Status of AVG or MIN/AVG/MAX recording (according to the instrument model)	03 / 04	2106	2	Bit encoding: b1(LSb)=status (0=stopped, 1=active) b2=memory full (0=no, 1=yes) b3=memory overwritten (0=no, 1=yes) e.g. \$0000\$0002=010 →recording stopped, memory full and no memory overwritten
Mode of AVG or MIN/AVG/MAX recording (according to the instrument model)	03 / 04 / 10	2108	2	\$01=fill, \$02=ring

Register description	F. code (Hex)	INTEGER		Programmable data
		Register (Hex)	Words	
INSTRUMENT GENERAL SETUP				
Rate of AVG or MIN/AVG/MAX recording (according to the instrument model)	03 / 04 / 10	210A	2	<u>BASIC instrument version:</u> \$00=disabled \$01=01 minute \$05=05 minutes \$0A=10 minutes \$0F=15 minutes \$1E=30 minutes \$2D=45 minutes \$3C=60 minutes <u>ENH instrument version:</u> \$0000=disabled \$0001...\$0E10 (1...3600 s, with 10 s step)
Reserved	03 / 04 / 10	210C	6	
MIN/AVG/MAX recording parameter for position 1	03 / 04 / 10	2112	2	Refer to the "Parameter codes" table
MIN/AVG/MAX recording parameter for position 2	03 / 04 / 10	2114	2	Refer to the "Parameter codes" table
MIN/AVG/MAX recording parameter for position 3	03 / 04 / 10	2116	2	Refer to the "Parameter codes" table
MIN/AVG/MAX recording parameter for position 4	03 / 04 / 10	2118	2	Refer to the "Parameter codes" table
MIN/AVG/MAX recording parameter for position 5	03 / 04 / 10	211A	2	Refer to the "Parameter codes" table
MIN/AVG/MAX recording parameter for position 6	03 / 04 / 10	211C	2	Refer to the "Parameter codes" table
MIN/AVG/MAX recording parameter for position 7	03 / 04 / 10	211E	2	Refer to the "Parameter codes" table
MIN/AVG/MAX recording parameter for position 8	03 / 04 / 10	2120	2	Refer to the "Parameter codes" table
MIN/AVG/MAX recording parameter for position 9	03 / 04 / 10	2122	2	Refer to the "Parameter codes" table
MIN/AVG/MAX recording parameter for position 10	03 / 04 / 10	2124	2	Refer to the "Parameter codes" table
MIN/AVG/MAX recording parameter for position 11	03 / 04 / 10	2126	2	Refer to the "Parameter codes" table
MIN/AVG/MAX recording parameter for position 12	03 / 04 / 10	2128	2	Refer to the "Parameter codes" table
MIN/AVG/MAX recording parameter for position 13	03 / 04 / 10	212A	2	Refer to the "Parameter codes" table
MIN/AVG/MAX recording parameter for position 14	03 / 04 / 10	212C	2	Refer to the "Parameter codes" table
MIN/AVG/MAX recording parameter for position 15	03 / 04 / 10	212E	2	Refer to the "Parameter codes" table
MIN/AVG/MAX recording parameter for position 16	03 / 04 / 10	2130	2	Refer to the "Parameter codes" table
MIN/AVG/MAX recording parameter for position 17	03 / 04 / 10	2132	2	Refer to the "Parameter codes" table
MIN/AVG/MAX recording parameter for position 18	03 / 04 / 10	2134	2	Refer to the "Parameter codes" table
MIN/AVG/MAX recording parameter for position 19	03 / 04 / 10	2136	2	Refer to the "Parameter codes" table
MIN/AVG/MAX recording parameter for position 20	03 / 04 / 10	2138	2	Refer to the "Parameter codes" table
MIN/AVG/MAX recording parameter for position 21	03 / 04 / 10	213A	2	Refer to the "Parameter codes" table
MIN/AVG/MAX recording parameter for position 22	03 / 04 / 10	213C	2	Refer to the "Parameter codes" table
MIN/AVG/MAX recording parameter for position 23	03 / 04 / 10	213E	2	Refer to the "Parameter codes" table
MIN/AVG/MAX recording parameter for position 24	03 / 04 / 10	2140	2	Refer to the "Parameter codes" table
Number of the stored Energy counter recordings	03 / 04	2142	2	e.g. \$007F=127 recordings
Timestamp of the first Energy counter recording	03 / 04	2144	2	UnixTime format. Convert the read hexadecimal value in decimal format. e.g. \$522E\$5FD4=1378770900 →09/09/13, 23:55:00
Timestamp of the last Energy counter recording	03 / 04	2146	2	UnixTime format. Convert the read hexadecimal value in decimal format. e.g. \$522E\$5FD4=1378770900 →09/09/13, 23:55:00

Register description	F. code (Hex)	INTEGER		Programmable data
		Register (Hex)	Words	
Energy counter recording status	03 / 04 / 10	2148	2	Bit encoding: b1(LSb)=status (0=stopped, 1=active) b2=memory full (0=no, 1=yes) b3=memory overwritten (0=no, 1=yes) e.g. \$0000\$0002=010 →recording stopped, memory full and no memory overwritten
Energy counter recording rate	03 / 04 / 10	214A	2	\$00=disabled, \$01...\$3C (1...60 min)

CODE (Hex)	Description	OUTPUTS AL=Digital Output, Alarm PLS=Digital Output, Pulse AO=Analog Output	REC-ENH MAM=Min/Avg/Max EC=Energy counters
------------	-------------	--------------------------------------------------------------------------------------	--------------------------------------------------

PARAMETER CODES

0000	None	AL, PLS, AO	MAM, EC
0001	V1 • Phase 1-N voltage	AL, AO	MAM
0002	V2 • Phase 2-N voltage	AL, AO	MAM
0003	V3 • Phase 3-N voltage	AL, AO	MAM
0004	V12 • Line 12 voltage	AL, AO	MAM
0005	V23 • Line 23 voltage	AL, AO	MAM
0006	V31 • Line 31 voltage	AL, AO	MAM
0007	V Σ • System voltage	AL, AO	MAM
0008	A1 • Phase 1 current	AL, AO	MAM
0009	A2 • Phase 2 current	AL, AO	MAM
000A	A3 • Phase 3 current	AL, AO	MAM
000B	AN • Neutral current*	AL, AO	MAM
000C	A Σ • System current	AL, AO	MAM
000D	P1 • Phase 1 active power	AL, AO	MAM
000E	P2 • Phase 2 active power	AL, AO	MAM
000F	P3 • Phase 3 active power	AL, AO	MAM
0010	P Σ • System active power	AL, AO	MAM
0011	S1 • Phase 1 apparent power	AL, AO	MAM
0012	S2 • Phase 2 apparent power	AL, AO	MAM
0013	S3 • Phase 3 apparent power	AL, AO	MAM
0014	S Σ • System apparent power	AL, AO	MAM
0015	Q1 • Phase 1 reactive power	AL, AO	MAM
0016	Q2 • Phase 2 reactive power	AL, AO	MAM
0017	Q3 • Phase 3 reactive power	AL, AO	MAM
0018	Q Σ • System reactive power	AL, AO	MAM
0019	PF1 • Phase 1 power factor	AL, AO	MAM
001A	PF2 • Phase 2 power factor	AL, AO	MAM
001B	PF3 • Phase 3 power factor	AL, AO	MAM
001C	PF Σ • System power factor	AL, AO	MAM
001D	DPF1 • Phase 1 DPF	AL, AO	MAM
001E	DPF2 • Phase 2 DPF	AL, AO	MAM
001F	DPF3 • Phase 3 DPF	AL, AO	MAM
0020	TAN \emptyset 1 • Phase 1 tangent \emptyset	AL, AO	MAM
0021	TAN \emptyset 2 • Phase 2 tangent \emptyset	AL, AO	MAM
0022	TAN \emptyset 3 • Phase 3 tangent \emptyset	AL, AO	MAM
0023	TAN $\emptyset\Sigma$ • System tangent \emptyset	AL, AO	MAM

■ Available only for instrument with Analog output.

■ Available only for ENH instrument version.

* The neutral current and the derivative parameters (AN, THDAN, HaAN) are not available if the set CT ratio or FSA value is different for each phase.

CODE (Hex)	Description	OUTPUTS		REC-ENH
		AL=Digital Output, Alarm PLS=Digital Output, Pulse AO=Analog Output		MAM=Min/Avg/Max EC=Energy counters
PARAMETER CODES				
0024	THDV1 • Phase 1-N voltage THD	AL, AO		MAM
0025	THDV2 • Phase 2-N voltage THD	AL, AO		MAM
0026	THDV3 • Phase 3-N voltage THD	AL, AO		MAM
0027	THDV12 • Line 12 voltage THD	AL, AO		MAM
0028	THDV23 • Line 23 voltage THD	AL, AO		MAM
0029	THDV31 • Line 31 voltage THD	AL, AO		MAM
002A	THDA1 • Phase 1 current THD	AL, AO		MAM
002B	THDA2 • Phase 2 current THD	AL, AO		MAM
002C	THDA3 • Phase 3 current THD	AL, AO		MAM
002D	THDAN • Neutral current THD*	AL, AO		MAM
002E	F • Frequency	AL, AO		MAM
002F	Phase sequence	AL		
0032	Active power sign	AL		
0040	$A1_{DMD}$ • Phase 1 current DMD	AL		
0041	$A2_{DMD}$ • Phase 2 current DMD	AL		
0042	$A3_{DMD}$ • Phase 3 current DMD	AL		
0043	AN_{DMD} • Neutral current DMD*	AL		
0044	$A\Sigma_{DMD}$ • System current DMD	AL		
0045	$+P1_{DMD}$ • Phase 1 imported active power DMD	AL		
0046	$-P1_{DMD}$ • Phase 1 exported active power DMD	AL		
0047	$+P2_{DMD}$ • Phase 2 imported active power DMD	AL		
0048	$-P2_{DMD}$ • Phase 2 exported active power DMD	AL		
0049	$+P3_{DMD}$ • Phase 3 imported active power DMD	AL		
004A	$-P3_{DMD}$ • Phase 3 exported active power DMD	AL		
004B	$+P\Sigma_{DMD}$ • System imported active power DMD	AL		
004C	$-P\Sigma_{DMD}$ • System exported active power DMD	AL		
004D	$P\Sigma_{DMD}BAL$ • Balance of system active power DMD	AL		
004E	$+S1_{DMD}$ • Phase 1 imported apparent power DMD	AL		
004F	$-S1_{DMD}$ • Phase 1 exported apparent power DMD	AL		
0050	$+S2_{DMD}$ • Phase 2 imported apparent power DMD	AL		
0051	$-S2_{DMD}$ • Phase 2 exported apparent power DMD	AL		
0052	$+S3_{DMD}$ • Phase 3 imported apparent power DMD	AL		
0053	$-S3_{DMD}$ • Phase 3 exported apparent power DMD	AL		
0054	$+S\Sigma_{DMD}$ • System imported apparent power DMD	AL		
0055	$-S\Sigma_{DMD}$ • System exported apparent power DMD	AL		
0056	$S\Sigma_{DMD}BAL$ • Balance of system apparent power DMD	AL		
0057	$+Q1_{DMD}$ • Phase 1 imported reactive power DMD	AL		
0058	$-Q1_{DMD}$ • Phase 1 exported reactive power DMD	AL		
0059	$+Q2_{DMD}$ • Phase 2 imported reactive power DMD	AL		
005A	$-Q2_{DMD}$ • Phase 2 exported reactive power DMD	AL		
005B	$+Q3_{DMD}$ • Phase 3 imported reactive power DMD	AL		
005C	$-Q3_{DMD}$ • Phase 3 exported reactive power DMD	AL		
005D	$+Q\Sigma_{DMD}$ • System imported reactive power DMD	AL		
005E	$-Q\Sigma_{DMD}$ • System exported reactive power DMD	AL		
005F	$Q\Sigma_{DMD}BAL$ • Balance of system reactive power DMD	AL		
0060	$+PF1_{DMD}$ • Phase 1 inductive power factor DMD	AL		
0061	$-PF1_{DMD}$ • Phase 1 capacitive power factor DMD	AL		
0062	$+PF2_{DMD}$ • Phase 2 inductive power factor DMD	AL		

■ Available only for ENH instrument version.

* The neutral current and the derivative parameters (AN, THDAN, HaAN) are not available if the set CT ratio or FSA value is different for each phase.

CODE (Hex)	Description	OUTPUTS	
		AL=Digital Output, Alarm PLS=Digital Output, Pulse AO=Analog Output	REC-ENH MAM=Min/Avg/Max EC=Energy counters
PARAMETER CODES			
0063	-PF2 _{DMD} • Phase 2 capacitive power factor DMD	AL	
0064	+PF3 _{DMD} • Phase 3 inductive power factor DMD	AL	
0065	-PF3 _{DMD} • Phase 3 capacitive power factor DMD	AL	
0066	+PF _{ΣDMD} • System inductive power factor DMD	AL	
0067	-PF _{ΣDMD} • System capacitive power factor DMD	AL	
00D7	+kWh1 • Phase 1 imported active energy	PLS	EC
00D8	-kWh1 • Phase 1 exported active energy	PLS	EC
00D9	+kWh2 • Phase 2 imported active energy	PLS	EC
00DA	-kWh2 • Phase 2 exported active energy	PLS	EC
00DB	+kWh3 • Phase 3 imported active energy	PLS	EC
00DC	-kWh3 • Phase 3 exported active energy	PLS	EC
00DD	+kWh _Σ • System imported active energy	PLS	EC
00DE	-kWh _Σ • System exported active energy	PLS	EC
00DF	kWh _Σ BAL • Balance of system active energy (imp-exp)		EC
00E0	+kVAh1-C • Phase 1 imported capacitive apparent energy	PLS	EC
00E1	-kVAh1-C • Phase 1 exported capacitive apparent energy	PLS	EC
00E2	+kVAh1-L • Phase 1 imported inductive apparent energy	PLS	EC
00E3	-kVAh1-L • Phase 1 exported inductive apparent energy	PLS	EC
00E4	+kVAh1 • Phase 1 imported apparent energy	PLS	EC
00E5	-kVAh1 • Phase 1 exported apparent energy	PLS	EC
00E6	+kVAh2-C • Phase 2 imported capacitive apparent energy	PLS	EC
00E7	-kVAh2-C • Phase 2 exported capacitive apparent energy	PLS	EC
00E8	+kVAh2-L • Phase 2 imported inductive apparent energy	PLS	EC
00E9	-kVAh2-L • Phase 2 exported inductive apparent energy	PLS	EC
00EA	+kVAh2 • Phase 2 imported apparent energy	PLS	EC
00EB	-kVAh2 • Phase 2 exported apparent energy	PLS	EC
00EC	+kVAh3-C • Phase 3 imported capacitive apparent energy	PLS	EC
00ED	-kVAh3-C • Phase 3 exported capacitive apparent energy	PLS	EC
00EE	+kVAh3-L • Phase 3 imported inductive apparent energy	PLS	EC
00EF	-kVAh3-L • Phase 3 exported inductive apparent energy	PLS	EC
00F0	+kVAh3 • Phase 3 imported apparent energy	PLS	EC
00F1	-kVAh3 • Phase 3 exported apparent energy	PLS	EC
00F2	+kVAh _Σ -C • System imported capacitive apparent energy	PLS	EC
00F3	-kVAh _Σ -C • System exported capacitive apparent energy	PLS	EC
00F4	+kVAh _Σ -L • System imported inductive apparent energy	PLS	EC
00F5	-kVAh _Σ -L • System exported inductive apparent energy	PLS	EC
00F6	+kVAh _Σ • System imported apparent energy	PLS	EC
00F7	-kVAh _Σ • System exported apparent energy	PLS	EC
00F8	kVAh _Σ BAL-C • Balance of system capacitive apparent en. (imp-exp)		EC
00F9	kVAh _Σ BAL-L • Balance of system inductive apparent en. (imp-exp)		EC
00FA	kVAh _Σ BAL • Balance of system apparent energy (imp-exp) (BAL-C + BAL-L)		EC
00FB	+kvarh1-C • Phase 1 imported capacitive reactive energy	PLS	EC
00FC	-kvarh1-C • Phase 1 exported capacitive reactive energy	PLS	EC
00FD	+kvarh1-L • Phase 1 imported inductive reactive energy	PLS	EC
00FE	-kvarh1-L • Phase 1 exported inductive reactive energy	PLS	EC
00FF	+kvarh2-C • Phase 2 imported capacitive reactive energy	PLS	EC
0100	-kvarh2-C • Phase 2 exported capacitive reactive energy	PLS	EC
0101	+kvarh2-L • Phase 2 imported inductive reactive energy	PLS	EC

■ Available only for instrument with separated Inductive and Capacitive apparent counters.

■ Available only for instrument with Total apparent counters (ind+cap).

CODE (Hex)	Description	OUTPUTS	
		AL=Digital Output, Alarm PLS=Digital Output, Pulse AO=Analog Output	REC-ENH MAM=Min/Avg/Max EC=Energy counters
PARAMETER CODES			
0102	-kvarh2-L • Phase 2 exported inductive reactive energy	PLS	EC
0103	+kvarh3-C • Phase 3 imported capacitive reactive energy	PLS	EC
0104	-kvarh3-C • Phase 3 exported capacitive reactive energy	PLS	EC
0105	+kvarh3-L • Phase 3 imported inductive reactive energy	PLS	EC
0106	-kvarh3-L • Phase 3 exported inductive reactive energy	PLS	EC
0107	+kvarh Σ -C • System imported capacitive reactive energy	PLS	EC
0108	-kvarh Σ -C • System exported capacitive reactive energy	PLS	EC
0109	+kvarh Σ -L • System imported inductive reactive energy	PLS	EC
010A	-kvarh Σ -L • System exported inductive reactive energy	PLS	EC
010B	kvarh Σ BAL-C • Balance of system capacitive reactive en. (imp-exp)		EC
010C	kvarh Σ BAL-L • Balance of system inductive reactive en. (imp-exp)		EC
010D	kvarh Σ BAL • Balance of system reactive energy (BAL-C + BAL-L)		EC
010E	HaV1 • Phase 1-N voltage component 0 (DC)		MAM
010F	HaV1 • Phase 1-N voltage component 1 st		MAM
0110	HaV1 • Phase 1-N voltage component 2 nd		MAM
0111	HaV1 • Phase 1-N voltage component 3 rd		MAM
0112	HaV1 • Phase 1-N voltage component 4 th		MAM
0113	HaV1 • Phase 1-N voltage component 5 th		MAM
0114	HaV1 • Phase 1-N voltage component 6 th		MAM
0115	HaV1 • Phase 1-N voltage component 7 th		MAM
0116	HaV1 • Phase 1-N voltage component 8 th		MAM
0117	HaV1 • Phase 1-N voltage component 9 th		MAM
0118	HaV1 • Phase 1-N voltage component 10 th		MAM
0119	HaV1 • Phase 1-N voltage component 11 th		MAM
011A	HaV1 • Phase 1-N voltage component 12 th		MAM
011B	HaV1 • Phase 1-N voltage component 13 th		MAM
011C	HaV1 • Phase 1-N voltage component 14 th		MAM
011D	HaV1 • Phase 1-N voltage component 15 th		MAM
011E	HaV2 • Phase 2-N voltage component 0 (DC)		MAM
011F	HaV2 • Phase 2-N voltage component 1 st		MAM
0120	HaV2 • Phase 2-N voltage component 2 nd		MAM
0121	HaV2 • Phase 2-N voltage component 3 rd		MAM
0122	HaV2 • Phase 2-N voltage component 4 th		MAM
0123	HaV2 • Phase 2-N voltage component 5 th		MAM
0124	HaV2 • Phase 2-N voltage component 6 th		MAM
0125	HaV2 • Phase 2-N voltage component 7 th		MAM
0126	HaV2 • Phase 2-N voltage component 8 th		MAM
0127	HaV2 • Phase 2-N voltage component 9 th		MAM
0128	HaV2 • Phase 2-N voltage component 10 th		MAM
0129	HaV2 • Phase 2-N voltage component 11 th		MAM
012A	HaV2 • Phase 2-N voltage component 12 th		MAM
012B	HaV2 • Phase 2-N voltage component 13 th		MAM
012C	HaV2 • Phase 2-N voltage component 14 th		MAM
012D	HaV2 • Phase 2-N voltage component 15 th		MAM
012E	HaV3 • Phase 3-N voltage component 0 (DC)		MAM
012F	HaV3 • Phase 3-N voltage component 1 st		MAM
0130	HaV3 • Phase 3-N voltage component 2 nd		MAM
0131	HaV3 • Phase 3-N voltage component 3 rd		MAM

■ Available only for ENH instrument version.

CODE (Hex)	Description	OUTPUTS		REC-ENH
		AL=Digital Output, Alarm	PLS=Digital Output, Pulse	MAM=Min/Avg/Max EC=Energy counters
PARAMETER CODES				
0132	HaV3 • Phase 3-N voltage component 4 th			MAM
0133	HaV3 • Phase 3-N voltage component 5 th			MAM
0134	HaV3 • Phase 3-N voltage component 6 th			MAM
0135	HaV3 • Phase 3-N voltage component 7 th			MAM
0136	HaV3 • Phase 3-N voltage component 8 th			MAM
0137	HaV3 • Phase 3-N voltage component 9 th			MAM
0138	HaV3 • Phase 3-N voltage component 10 th			MAM
0139	HaV3 • Phase 3-N voltage component 11 th			MAM
013A	HaV3 • Phase 3-N voltage component 12 th			MAM
013B	HaV3 • Phase 3-N voltage component 13 th			MAM
013C	HaV3 • Phase 3-N voltage component 14 th			MAM
013D	HaV3 • Phase 3-N voltage component 15 th			MAM
013E	HaV12 • Line 12 voltage component 0 (DC)			MAM
013F	HaV12 • Line 12 voltage component 1 st			MAM
0140	HaV12 • Line 12 voltage component 2 nd			MAM
0141	HaV12 • Line 12 voltage component 3 rd			MAM
0142	HaV12 • Line 12 voltage component 4 th			MAM
0143	HaV12 • Line 12 voltage component 5 th			MAM
0144	HaV12 • Line 12 voltage component 6 th			MAM
0145	HaV12 • Line 12 voltage component 7 th			MAM
0146	HaV12 • Line 12 voltage component 8 th			MAM
0147	HaV12 • Line 12 voltage component 9 th			MAM
0148	HaV12 • Line 12 voltage component 10 th			MAM
0149	HaV12 • Line 12 voltage component 11 th			MAM
014A	HaV12 • Line 12 voltage component 12 th			MAM
014B	HaV12 • Line 12 voltage component 13 th			MAM
014C	HaV12 • Line 12 voltage component 14 th			MAM
014D	HaV12 • Line 12 voltage component 15 th			MAM
014E	HaV23 • Line 23 voltage component 0 (DC)			MAM
014F	HaV23 • Line 23 voltage component 1 st			MAM
0150	HaV23 • Line 23 voltage component 2 nd			MAM
0151	HaV23 • Line 23 voltage component 3 rd			MAM
0152	HaV23 • Line 23 voltage component 4 th			MAM
0153	HaV23 • Line 23 voltage component 5 th			MAM
0154	HaV23 • Line 23 voltage component 6 th			MAM
0155	HaV23 • Line 23 voltage component 7 th			MAM
0156	HaV23 • Line 23 voltage component 8 th			MAM
0157	HaV23 • Line 23 voltage component 9 th			MAM
0158	HaV23 • Line 23 voltage component 10 th			MAM
0159	HaV23 • Line 23 voltage component 11 th			MAM
015A	HaV23 • Line 23 voltage component 12 th			MAM
015B	HaV23 • Line 23 voltage component 13 th			MAM
015C	HaV23 • Line 23 voltage component 14 th			MAM
015D	HaV23 • Line 23 voltage component 15 th			MAM
015E	HaV31 • Line 31 voltage component 0 (DC)			MAM
015F	HaV31 • Line 31 voltage component 1 st			MAM
0160	HaV31 • Line 31 voltage component 2 nd			MAM
0161	HaV31 • Line 31 voltage component 3 rd			MAM

■ Available only for ENH instrument version.

CODE (Hex)	Description	OUTPUTS		REC-ENH
		AL=Digital Output, Alarm	PLS=Digital Output, Pulse	MAM=Min/Avg/Max EC=Energy counters
PARAMETER CODES				
0162	HaV31 • Line 31 voltage component 4 th			MAM
0163	HaV31 • Line 31 voltage component 5 th			MAM
0164	HaV31 • Line 31 voltage component 6 th			MAM
0165	HaV31 • Line 31 voltage component 7 th			MAM
0166	HaV31 • Line 31 voltage component 8 th			MAM
0167	HaV31 • Line 31 voltage component 9 th			MAM
0168	HaV31 • Line 31 voltage component 10 th			MAM
0169	HaV31 • Line 31 voltage component 11 th			MAM
016A	HaV31 • Line 31 voltage component 12 th			MAM
016B	HaV31 • Line 31 voltage component 13 th			MAM
016C	HaV31 • Line 31 voltage component 14 th			MAM
016D	HaV31 • Line 31 voltage component 15 th			MAM
016E	HaA1 • Phase 1 current component 0 (DC)			MAM
016F	HaA1 • Phase 1 current component 1 st			MAM
0170	HaA1 • Phase 1 current component 2 nd			MAM
0171	HaA1 • Phase 1 current component 3 rd			MAM
0172	HaA1 • Phase 1 current component 4 th			MAM
0173	HaA1 • Phase 1 current component 5 th			MAM
0174	HaA1 • Phase 1 current component 6 th			MAM
0175	HaA1 • Phase 1 current component 7 th			MAM
0176	HaA1 • Phase 1 current component 8 th			MAM
0177	HaA1 • Phase 1 current component 9 th			MAM
0178	HaA1 • Phase 1 current component 10 th			MAM
0179	HaA1 • Phase 1 current component 11 th			MAM
017A	HaA1 • Phase 1 current component 12 th			MAM
017B	HaA1 • Phase 1 current component 13 th			MAM
017C	HaA1 • Phase 1 current component 14 th			MAM
017D	HaA1 • Phase 1 current component 15 th			MAM
017E	HaA2 • Phase 2 current component 0 (DC)			MAM
017F	HaA2 • Phase 2 current component 1 st			MAM
0180	HaA2 • Phase 2 current component 2 nd			MAM
0181	HaA2 • Phase 2 current component 3 rd			MAM
0182	HaA2 • Phase 2 current component 4 th			MAM
0183	HaA2 • Phase 2 current component 5 th			MAM
0184	HaA2 • Phase 2 current component 6 th			MAM
0185	HaA2 • Phase 2 current component 7 th			MAM
0186	HaA2 • Phase 2 current component 8 th			MAM
0187	HaA2 • Phase 2 current component 9 th			MAM
0188	HaA2 • Phase 2 current component 10 th			MAM
0189	HaA2 • Phase 2 current component 11 th			MAM
018A	HaA2 • Phase 2 current component 12 th			MAM
018B	HaA2 • Phase 2 current component 13 th			MAM
018C	HaA2 • Phase 2 current component 14 th			MAM
018D	HaA2 • Phase 2 current component 15 th			MAM
018E	HaA3 • Phase 3 current component 0 (DC)			MAM
018F	HaA3 • Phase 3 current component 1 st			MAM
0190	HaA3 • Phase 3 current component 2 nd			MAM
0191	HaA3 • Phase 3 current component 3 rd			MAM

■ Available only for ENH instrument version.

CODE (Hex)	Description	OUTPUTS		REC-ENH
		AL=Digital Output, Alarm	PLS=Digital Output, Pulse	MAM=Min/Avg/Max EC=Energy counters
PARAMETER CODES				
0192	HaA3 • Phase 3 current component 4 th			MAM
0193	HaA3 • Phase 3 current component 5 th			MAM
0194	HaA3 • Phase 3 current component 6 th			MAM
0195	HaA3 • Phase 3 current component 7 th			MAM
0196	HaA3 • Phase 3 current component 8 th			MAM
0197	HaA3 • Phase 3 current component 9 th			MAM
0198	HaA3 • Phase 3 current component 10 th			MAM
0199	HaA3 • Phase 3 current component 11 th			MAM
019A	HaA3 • Phase 3 current component 12 th			MAM
019B	HaA3 • Phase 3 current component 13 th			MAM
019C	HaA3 • Phase 3 current component 14 th			MAM
019D	HaA3 • Phase 3 current component 15 th			MAM
019E	HaAN • Neutral current component 0 (DC) *			MAM
019F	HaAN • Neutral current component 1 st *			MAM
01A0	HaAN • Neutral current component 2 nd *			MAM
01A1	HaAN • Neutral current component 3 rd *			MAM
01A2	HaAN • Neutral current component 4 th *			MAM
01A3	HaAN • Neutral current component 5 th *			MAM
01A4	HaAN • Neutral current component 6 th *			MAM
01A5	HaAN • Neutral current component 7 th *			MAM
01A6	HaAN • Neutral current component 8 th *			MAM
01A7	HaAN • Neutral current component 9 th *			MAM
01A8	HaAN • Neutral current component 10 th *			MAM
01A9	HaAN • Neutral current component 11 th *			MAM
01AA	HaAN • Neutral current component 12 th *			MAM
01AB	HaAN • Neutral current component 13 th *			MAM
01AC	HaAN • Neutral current component 14 th *			MAM
01AD	HaAN • Neutral current component 15 th *			MAM

■ Available only for ENH instrument version.

* The neutral current and the derivative parameters (AN, THDAN, HaAN) are not available if the set CT ratio or FSA value is different for each phase.

Register description	F. code (Hex)	INTEGER		Programmable data
		Register (Hex)	Words	
RECORDING DOWNLOAD				
Prepare data for downloading (according to the instrumenting model)	10	F000	2	\$01=prepare AVG or MIN/AVG/MAX rec. (according to the instr. model) \$02=prepare Energy rec. (only ENH instr.)
Delete recorded data (irreversible operation)	10	F002	2	\$01=delete AVG or MIN/AVG/MAX rec. (according to the instr. model) \$02=delete Energy rec. (only ENH instr.) \$03=delete all rec. (only ENH instr.)
Read the record/s block previously downloaded (do not consider the first word). The download block always contains an integer record number. For the block structure refer to the description of \$F101 register.	03 / 04	F100	1+ ≤124	Set the word number considering that the download block must contain an integer record number + 1 word. Each record contains only the enabled parameters + timestamp. Example 1: 109 words=\$006D Example 2: 105 words=\$0069 Example 3: 75 words=\$004B
Download and read the first/next record/s block. Example 1 (BASIC instrument version) Active&reactive powers, 16 values; the record length is 2(timestamp)+16 words=18(\$12); the download block will contain 6 records. Example 2 (ENH instrument version) With 4 parameters enabled for recording: 24 values; the record length is 2(timestamp)+24 words=26(\$1A); the download block will contain 4 records. Example 3 (ENH instrument version) With 24 parameters enabled for recording: 72 values; the record length is 2(timestamp)+72 words=74(\$4A); the download block will contain 1 record.	03 / 04	F101	≤124	Set the word number considering that the download block must contain an integer record number. Each record contains only the enabled parameters + timestamp. Example 1: 108 words=\$006C Example 2: 104 words=\$0068 Example 3: 74 words=\$004A

Register description	Value format	Words
AVG RECORDING PARAMETER BLOCK (FIXED) - BASIC VERSION		
Timestamp of the record block	UnixTime	2
+P1 _{AVG} • Phase 1 imported active power AVG	0.005% FS	1
-P1 _{AVG} • Phase 1 exported active power AVG	0.005% FS	1
+P2 _{AVG} • Phase 2 imported active power AVG	0.005% FS	1
-P2 _{AVG} • Phase 2 exported active power AVG	0.005% FS	1
+P3 _{AVG} • Phase 3 imported active power AVG	0.005% FS	1
-P3 _{AVG} • Phase 3 exported active power AVG	0.005% FS	1
+P Σ _{AVG} • System imported active power AVG	0.005% FS	1
-P Σ _{AVG} • System exported active power AVG	0.005% FS	1
+Q1 _{AVG} • Phase 1 imported reactive power AVG	0.005% FS	1
-Q1 _{AVG} • Phase 1 exported reactive power AVG	0.005% FS	1
+Q2 _{AVG} • Phase 2 imported reactive power AVG	0.005% FS	1
-Q2 _{AVG} • Phase 2 exported reactive power AVG	0.005% FS	1
+Q3 _{AVG} • Phase 3 imported reactive power AVG	0.005% FS	1
-Q3 _{AVG} • Phase 3 exported reactive power AVG	0.005% FS	1
+Q Σ _{AVG} • System imported reactive power AVG	0.005% FS	1
-Q Σ _{AVG} • System exported reactive power AVG	0.005% FS	1

Register description	Value format	Words
MIN/AVG/MAX RECORDING PARAMETER BLOCK - ENH VERSION		
Timestamp of the record block	UnixTime	2
1 _{MIN} • MIN value - parameter position 1	0.005% FS	1
1 _{AVG} • AVG value - parameter position 1	0.005% FS	1
1 _{MAX} • MAX value - parameter position 1	0.005% FS	1
2 _{MIN} • MIN value - parameter position 2	0.005% FS	1
2 _{AVG} • AVG value - parameter position 2	0.005% FS	1
2 _{MAX} • MAX value - parameter position 2	0.005% FS	1
3 _{MIN} • MIN value - parameter position 3	0.005% FS	1
3 _{AVG} • AVG value - parameter position 3	0.005% FS	1
3 _{MAX} • MAX value - parameter position 3	0.005% FS	1
4 _{MIN} • MIN value - parameter position 4	0.005% FS	1
4 _{AVG} • AVG value - parameter position 4	0.005% FS	1
4 _{MAX} • MAX value - parameter position 4	0.005% FS	1
5 _{MIN} • MIN value - parameter position 5	0.005% FS	1
5 _{AVG} • AVG value - parameter position 5	0.005% FS	1
5 _{MAX} • MAX value - parameter position 5	0.005% FS	1
6 _{MIN} • MIN value - parameter position 6	0.005% FS	1
6 _{AVG} • AVG value - parameter position 6	0.005% FS	1
6 _{MAX} • MAX value - parameter position 6	0.005% FS	1
7 _{MIN} • MIN value - parameter position 7	0.005% FS	1
7 _{AVG} • AVG value - parameter position 7	0.005% FS	1
7 _{MAX} • MAX value - parameter position 7	0.005% FS	1
8 _{MIN} • MIN value - parameter position 8	0.005% FS	1
8 _{AVG} • AVG value - parameter position 8	0.005% FS	1
8 _{MAX} • MAX value - parameter position 8	0.005% FS	1
9 _{MIN} • MIN value - parameter position 9	0.005% FS	1
9 _{AVG} • AVG value - parameter position 9	0.005% FS	1
9 _{MAX} • MAX value - parameter position 9	0.005% FS	1
10 _{MIN} • MIN value - parameter position 10	0.005% FS	1
10 _{AVG} • AVG value - parameter position 10	0.005% FS	1
10 _{MAX} • MAX value - parameter position 10	0.005% FS	1
11 _{MIN} • MIN value - parameter position 11	0.005% FS	1
11 _{AVG} • AVG value - parameter position 11	0.005% FS	1
11 _{MAX} • MAX value - parameter position 11	0.005% FS	1
12 _{MIN} • MIN value - parameter position 12	0.005% FS	1
12 _{AVG} • AVG value - parameter position 12	0.005% FS	1
12 _{MAX} • MAX value - parameter position 12	0.005% FS	1
13 _{MIN} • MIN value - parameter position 13	0.005% FS	1
13 _{AVG} • AVG value - parameter position 13	0.005% FS	1
13 _{MAX} • MAX value - parameter position 13	0.005% FS	1
14 _{MIN} • MIN value - parameter position 14	0.005% FS	1
14 _{AVG} • AVG value - parameter position 14	0.005% FS	1
14 _{MAX} • MAX value - parameter position 14	0.005% FS	1
15 _{MIN} • MIN value - parameter position 15	0.005% FS	1
15 _{AVG} • AVG value - parameter position 15	0.005% FS	1
15 _{MAX} • MAX value - parameter position 15	0.005% FS	1

■ Available only for ENH instrument version.

Register description	Value format	Words
MIN/AVG/MAX RECORDING PARAMETER BLOCK - ENH VERSION		
16 _{MIN} • MIN value - parameter position 16	0.005% FS	1
16 _{AVG} • AVG value - parameter position 16	0.005% FS	1
16 _{MAX} • MAX value - parameter position 16	0.005% FS	1
17 _{MIN} • MIN value - parameter position 17	0.005% FS	1
17 _{AVG} • AVG value - parameter position 17	0.005% FS	1
17 _{MAX} • MAX value - parameter position 17	0.005% FS	1
18 _{MIN} • MIN value - parameter position 18	0.005% FS	1
18 _{AVG} • AVG value - parameter position 18	0.005% FS	1
18 _{MAX} • MAX value - parameter position 18	0.005% FS	1
19 _{MIN} • MIN value - parameter position 19	0.005% FS	1
19 _{AVG} • AVG value - parameter position 19	0.005% FS	1
19 _{MAX} • MAX value - parameter position 19	0.005% FS	1
20 _{MIN} • MIN value - parameter position 20	0.005% FS	1
20 _{AVG} • AVG value - parameter position 20	0.005% FS	1
20 _{MAX} • MAX value - parameter position 20	0.005% FS	1
21 _{MIN} • MIN value - parameter position 21	0.005% FS	1
21 _{AVG} • AVG value - parameter position 21	0.005% FS	1
21 _{MAX} • MAX value - parameter position 21	0.005% FS	1
22 _{MIN} • MIN value - parameter position 22	0.005% FS	1
22 _{AVG} • AVG value - parameter position 22	0.005% FS	1
22 _{MAX} • MAX value - parameter position 22	0.005% FS	1
23 _{MIN} • MIN value - parameter position 23	0.005% FS	1
23 _{AVG} • AVG value - parameter position 23	0.005% FS	1
23 _{MAX} • MAX value - parameter position 23	0.005% FS	1
24 _{MIN} • MIN value - parameter position 24	0.005% FS	1
24 _{AVG} • AVG value - parameter position 24	0.005% FS	1
24 _{MAX} • MAX value - parameter position 24	0.005% FS	1

Register description	Value format	Words (IEEE)
ENERGY COUNTER RECORDING PARAMETER BLOCK - ENH VERSION		
Timestamp of the record block	UnixTime	2
+kWh1 • Phase 1 imported active energy	0.1 Wh	2
-kWh1 • Phase 1 exported active energy	0.1 Wh	2
+kWh2 • Phase 2 imported active energy	0.1 Wh	2
-kWh2 • Phase 2 exported active energy	0.1 Wh	2
+kWh3 • Phase 3 imported active energy	0.1 Wh	2
-kWh3 • Phase 3 exported active energy	0.1 Wh	2
+kWh Σ • System imported active energy	0.1 Wh	2
-kWh Σ • System exported active energy	0.1 Wh	2
kWh Σ BAL • Balance of system active energy (imp-exp)	0.1 Wh	2
+kVAh1-C • Phase 1 imported capacitive apparent energy	0.1 VAh	2
-kVAh1-C • Phase 1 exported capacitive apparent energy	0.1 VAh	2
+kVAh1-L • Phase 1 imported inductive apparent energy	0.1 VAh	2
-kVAh1-L • Phase 1 exported inductive apparent energy	0.1 VAh	2
+kVAh1 • Phase 1 imported apparent energy	0.1 VAh	2
-kVAh1 • Phase 1 exported apparent energy	0.1 VAh	2
+kVAh2-C • Phase 2 imported capacitive apparent energy	0.1 VAh	2
-kVAh2-C • Phase 2 exported capacitive apparent energy	0.1 VAh	2
+kVAh2-L • Phase 2 imported inductive apparent energy	0.1 VAh	2
-kVAh2-L • Phase 2 exported inductive apparent energy	0.1 VAh	2
+kVAh2 • Phase 2 imported apparent energy	0.1 VAh	2
-kVAh2 • Phase 2 exported apparent energy	0.1 VAh	2
+kVAh3-C • Phase 3 imported capacitive apparent energy	0.1 VAh	2
-kVAh3-C • Phase 3 exported capacitive apparent energy	0.1 VAh	2
+kVAh3-L • Phase 3 imported inductive apparent energy	0.1 VAh	2
-kVAh3-L • Phase 3 exported inductive apparent energy	0.1 VAh	2
+kVAh3 • Phase 3 imported apparent energy	0.1 VAh	2
-kVAh3 • Phase 3 exported apparent energy	0.1 VAh	2
+kVAh Σ -C • System imported capacitive apparent energy	0.1 VAh	2
-kVAh Σ -C • System exported capacitive apparent energy	0.1 VAh	2
+kVAh Σ -L • System imported inductive apparent energy	0.1 VAh	2
-kVAh Σ -L • System exported inductive apparent energy	0.1 VAh	2
+kVAh Σ • System imported apparent energy	0.1 VAh	2
-kVAh Σ • System exported apparent energy	0.1 VAh	2
kVAh Σ BAL-C • Balance of system capacitive apparent en. (imp-exp)	0.1 VAh	2
kVAh Σ BAL-L • Balance of system inductive apparent en. (imp-exp)	0.1 VAh	2
kVAh Σ BAL • Balance of system apparent energy (imp-exp) (BAL-C + BAL-L)	0.1 VAh	2
+kvarh1-C • Phase 1 imported capacitive reactive energy	0.1 varh	2
-kvarh1-C • Phase 1 exported capacitive reactive energy	0.1 varh	2
+kvarh1-L • Phase 1 imported inductive reactive energy	0.1 varh	2
-kvarh1-L • Phase 1 exported inductive reactive energy	0.1 varh	2
+kvarh2-C • Phase 2 imported capacitive reactive energy	0.1 varh	2
-kvarh2-C • Phase 2 exported capacitive reactive energy	0.1 varh	2
+kvarh2-L • Phase 2 imported inductive reactive energy	0.1 varh	2
-kvarh2-L • Phase 2 exported inductive reactive energy	0.1 varh	2
+kvarh3-C • Phase 3 imported capacitive reactive energy	0.1 varh	2
-kvarh3-C • Phase 3 exported capacitive reactive energy	0.1 varh	2

■ Available only for instrument with separated Inductive and Capacitive apparent counters.

■ Available only for instrument with Total apparent counters (ind+cap).

■ Available only for ENH instrument version.

Register description	Value format	Words (IEEE)
ENERGY COUNTER RECORDING PARAMETER BLOCK - ENH VERSION		
+kvarh3-L • Phase 3 imported inductive reactive energy	0.1 varh	2
-kvarh3-L • Phase 3 exported inductive reactive energy	0.1 varh	2
+kvarhΣ-C • System imported capacitive reactive energy	0.1 varh	2
-kvarhΣ-C • System exported capacitive reactive energy	0.1 varh	2
+kvarhΣ-L • System imported inductive reactive energy	0.1 varh	2
-kvarhΣ-L • System exported inductive reactive energy	0.1 varh	2
kvarhΣBAL-C • Balance of system capacitive reactive en. (imp-exp)	0.1 varh	2
kvarhΣBAL-L • Balance of system inductive reactive en. (imp-exp)	0.1 varh	2
kvarhΣBAL • Balance of system reactive energy (BAL-C + BAL-L)	0.1 varh	2

4.3 CONSIDERATIONS ON THE FULL SCALE VALUE CALCULATION

The full scale value calculation can change according to the instrument model (1/5A CT or Rogowski). The following description shows the formulas for each model.

1/5A CT instrument

The phase power full scale is the result of a multiplication between PT primary and phase X CT primary (X=1, 2 or 3). If the PT primary and secondary values are set to 1 (direct connection), the phase power full scale is the result of a multiplication between 290V and phase X CT primary (X=1, 2 or 3).

Example: formula for phase 1 power full scale

$$FS_{P1,S1,Q1} = PT_{pri} * CT_{pri} \quad \text{if } PT_{pri} = PT_{sec} = 1 \rightarrow FS_{P1,S1,Q1} = 290V * CT_{pri}$$

The system power full scale is the result of a multiplication between 3 and PT primary and max phase CT primary. If the PT primary and secondary values are set to 1 (direct connection), the system power full scale is the result of a multiplication between 3 and 290V and max phase CT primary.

Example: formula for system power full scale

$$FS_{P\Sigma,S\Sigma,Q\Sigma} = 3 * PT_{pri} * CT_{priMAX} \quad \text{if } PT_{pri} = PT_{sec} = 1 \rightarrow FS_{P\Sigma,S\Sigma,Q\Sigma} = 3 * 290V * CT_{priMAX}$$

Rogowski instrument

The phase power full scale is the result of a multiplication between PT primary and phase X current full scale (X=1, 2 or 3). If the PT primary and secondary values are set to 1 (direct connection), the phase power full scale is the result of a multiplication between 290V and phase X current full scale (X=1, 2 or 3).

For the current full scale value to be used in the formula, consider the following values according to the selected instrument scale:

$$\text{Scale 500A} \rightarrow FS_A = 700A$$

$$\text{Scale 4000A} \rightarrow FS_A = 5600A$$

$$\text{Scale 20000A} \rightarrow FS_A = 28000A$$

Example: formula for phase 1 power full scale

$$FS_{P1,S1,Q1} = PT_{pri} * FS_{A1} \quad \text{if } PT_{pri} = PT_{sec} = 1 \rightarrow FS_{P1,S1,Q1} = 290V * FS_{A1}$$

The system power full scale is the result of a multiplication between 3 and PT primary and max phase current full scale. If the PT primary and secondary values are set to 1 (direct connection), the system power full scale is the result of a multiplication between 3 and 290V and max phase current full scale.

Example: formula for system power full scale

$$FS_{P\Sigma,S\Sigma,Q\Sigma} = 3 * PT_{pri} * FS_{AMAX} \quad \text{if } PT_{pri} = PT_{sec} = 1 \rightarrow FS_{P\Sigma,S\Sigma,Q\Sigma} = 3 * 290V * FS_{AMAX}$$

5. READING COMMAND EXAMPLES

In this chapter, some reading command examples are described according to the used communication protocol (RTU or TCP).

5.1 MODBUS RTU

The following tables show some reading examples in MODBUS RTU.

Values contained both in Query and Response messages are in hex format.

CURRENT VALUE READING

Query example: 0103000E000A0EA4

Example	Byte	Description
01	-	Slave address
03	-	Function code
00	High	Starting register
0E	Low	
00	High	10 words to be read
0A	Low	
0E	High	CRC
A4	Low	

Response example: 010314000009990000099F00000990000001900000998C070

Example	Byte	Description
01	-	Slave address
03	-	Function code
14	-	20 data bytes
00	High	2457 mA phase 1 current (A1)
00	Low	
09	High	
99	Low	
00	High	2463 mA phase 2 current (A2)
00	Low	
09	High	
9F	Low	
00	High	2448 mA phase 3 current (A3)
00	Low	
09	High	
90	Low	
00	High	25 mA neutral current (AN)
00	Low	
00	High	
19	Low	
00	High	2456 mA system current (A Σ)
00	Low	
09	High	
98	Low	
C0	High	CRC
70	Low	

WIRING MODE READING

Query example: 0103203C0002C70F

Example	Byte	Description
01	-	Slave address
03	-	Function code
20	High	Starting register
3C	Low	
00	High	2 words to be read
02	Low	
C7	High	CRC
0F	Low	

Response example: 01030400018599

Example	Byte	Description
01	-	Slave address
03	-	Function code
04	-	4 data bytes
00	High	3 phase, 4 wire, 3 current wiring mode
00	Low	
00	High	
01	Low	
85	High	CRC
99	Low	

5.2 MODBUS TCP

The following tables show some reading examples in MODBUS TCP.

Values contained both in Query and Response messages are in hex format.

CURRENT VALUE READING

Query example: 0100000000060103000E000A

Example	Byte	Description
01	-	Transaction ID
00	High	Protocol ID
00	Low	
00	High	
00	Low	
06	-	6 data bytes
01	-	Unit ID
03	-	Function code
00	High	Starting register
0E	Low	
00	High	10 words to be read
0A	Low	

Response example: 01000000000314000009990000099F000009900000001900000998

Example	Byte	Description
01	-	Transaction ID
00	High	Protocol ID
00	Low	
00	High	
00	Low	
16	-	22 data bytes
01	-	Unit ID
03	-	Function code
14	-	20 reading bytes
00	High	2457 mA phase 1 current (A1)
00	Low	
09	High	
99	Low	
00	High	2463 mA phase 2 current (A2)
00	Low	
09	High	
9F	Low	
00	High	2448 mA phase 3 current (A3)
00	Low	
09	High	
90	Low	
00	High	25 mA neutral current (AN)
00	Low	
00	High	
19	Low	
00	High	2456 mA system current (AΣ)
00	Low	
09	High	
98	Low	

WIRING MODE READING

Query example: 0100000000060103203C0002

Example	Byte	Description
01	-	Transaction ID
00	High	Protocol ID
00	Low	
00	High	
00	Low	
06	-	6 data bytes
01	-	Unit ID
03	-	Function code
20	High	Starting register
3C	Low	
00	High	2 words to be read
02	Low	

Response example: 01000000000701030400000001

Example	Byte	Description
01	-	Transaction ID
00	High	Protocol ID
00	Low	
00	High	
00	Low	
07	-	7 data bytes
01	-	Unit ID
03	-	Function code
04	-	4 reading bytes
00	High	3 phase, 4 wire, 3 current wiring mode
00	Low	
00	High	
01	Low	

6. WRITING COMMAND EXAMPLES

In this chapter, some writing command examples are described according to the used communication protocol (RTU or TCP).

6.1 MODBUS RTU

The following tables show some writing examples in MODBUS RTU.

Values contained in Command, Query and Response messages are in hex format.

WIRING MODE SETUP

Command example: 0110203C000204000000032E29

Example	Byte	Description
01	-	Slave address
10	-	Function code
20	High	Starting register
3C	Low	
00	High	2 words to be written
02	Low	
04	-	4 data bytes
00	High	Set 1 phase wiring mode
00	Low	
00	High	
03	Low	
2E	High	CRC
29	Low	

Response example: 0110203C0002048A

Example	Byte	Description
01	-	Slave address
10	-	Function code
20	High	Starting register
3C	Low	
00	High	2 written words
02	Low	
04	High	CRC
8A	Low	

DATE&TIME SETUP

Command example: 0110204A000204522E5FD43FA7

Example	Byte	Description
01	-	Slave address
10	-	Function code
20	High	Starting register
4A	Low	
00	High	2 words to be written
02	Low	
04	-	4 data bytes
52	High	Set 9 th September 2013, 23:55:00
2E	Low	
5F	High	
D4	Low	
3F	High	CRC
A7	Low	

Response example: 0110204A0002DE6B

Example	Byte	Description
01	-	Slave address
10	-	Function code
20	High	Starting register
4A	Low	
00	High	2 written words
02	Low	
DE	High	CRC
6B	Low	

RECORDING DOWNLOAD FOR BASIC INSTRUMENT VERSION

1° STEP: prepare data for downloading

Command example: 0110F000000204000000016B36

Example	Byte	Description
01	-	Slave address
10	-	Function code
F0	High	Starting register
00	Low	
00	High	2 words to be written
02	Low	
04	-	4 data bytes
00	High	Prepare data for downloading
00	Low	
00	High	
01	Low	
6B	High	CRC
36	Low	

Response example: 0110F000000272C8

Example	Byte	Description
01	-	Slave address
10	-	Function code
F0	High	Starting register
00	Low	
00	High	2 written words
02	Low	
72	High	CRC
C8	Low	

2° STEP: perform the data download by a reading command

Query example: 0104F101006C931B

Example	Byte	Description
01	-	Slave address
04	-	Function code
F1	High	Starting register
01	Low	
00	High	108 words to be read
6C	Low	
0B	High	CRC
3B	Low	

Response example:

01 04 D8

53FDAEF0 05FC 0000 05FB 0000 05FA 0000 05FB 0000 002E 0000 002D 0000 0030 0000 002F 0000
 53FDAF2C 0955 0000 0953 0000 0953 0000 0954 0000 003C 0000 003C 0000 003F 0000 003D 0000
 53FDAF68 10BB 0000 10B9 0000 10B8 0000 10BA 0000 0057 0000 0057 0000 005B 0000 0059 0000
 53FDAFA4 10C4 0000 10C2 0000 10C1 0000 10C2 0000 0057 0000 0057 0000 005B 0000 0059 0000
 53FDAFE0 10BF 0000 10BD 0000 10BC 0000 10BE 0000 0057 0000 0058 0000 005C 0000 0059 0000
 53FDB01C 10C1 0000 10BF 0000 10BE 0000 10BF 0000 0057 0000 0058 0000 005C 0000 0059 0000
 A26C

Example	Byte	Description
01	-	Slave address
04	-	Function code
D8	-	216 data bytes
53 FD AE F0	High Low High Low	27 th August 2014, 10:12:00 record block
05 FC	High Low	0,111 kW phase 1 imported active power AVG (+P1 _{AVG})
00 00	High Low	0 kW phase 1 exported active power AVG (-P1 _{AVG})
05 FB	High Low	0,111 kW phase 2 imported active power AVG (+P2 _{AVG})
00 00	High Low	0 kW phase 2 exported active power AVG (-P2 _{AVG})
05 FA	High Low	0,111 kW phase 3 imported active power AVG (+P3 _{AVG})
00 00	High Low	0 kW phase 3 exported active power AVG (-P3 _{AVG})
05 FB	High Low	0,333 kW system imported active power AVG (+P _{ΣAVG})
00 00	High Low	0 kW system exported active power AVG (-P _{ΣAVG})
00 2E	High Low	0,003 kvar phase 1 imported reactive power AVG (+Q1 _{AVG})
00 00	High Low	0 kvar phase 1 exported reactive power AVG (-Q1 _{AVG})
00 2D	High Low	0,003 kvar phase 2 imported reactive power AVG (+Q2 _{AVG})
00 00	High Low	0 kvar phase 2 exported reactive power AVG (-Q2 _{AVG})
00 30	High Low	0,003 kvar phase 3 imported reactive power AVG (+Q3 _{AVG})
00 00	High Low	0 kvar phase 3 exported reactive power AVG (-Q3 _{AVG})
00 2F	High Low	0,010 kvar system imported reactive power AVG (+Q _{ΣAVG})
00 00	High Low	0 kvar system exported reactive power AVG (-Q _{ΣAVG})
53 FD AF 2C	High Low High Low	27 th August 2014, 10:13:00 record block
09 55	High Low	0,15 kW phase 1 imported active power AVG (+P1 _{AVG})
A2 6C	High Low	CRC

1ST RECORD

2ND RECORD

RECORDING DOWNLOAD FOR ENH INSTRUMENT VERSION

Example with +P Σ , +Q Σ , +S Σ parameters enabled for recording.

1° STEP: prepare data for downloading

Command example: 0110F000000204000000016B36

Example	Byte	Description
01	-	Slave address
10	-	Function code
F0	High	Starting register
00	Low	
00	High	2 words to be written
02	Low	
04	-	4 data bytes
00	High	Prepare data for downloading
00	Low	
00	High	
01	Low	
6B	High	CRC
36	Low	

Response example: 0110F000000272C8

Example	Byte	Description
01	-	Slave address
10	-	Function code
F0	High	Starting register
00	Low	
00	High	2 written words
02	Low	
72	High	CRC
C8	Low	

2° STEP: perform the data download by a reading command

Query example: 0104F101006E12DA

Example	Byte	Description
01	-	Slave address
04	-	Function code
F1	High	Starting register
01	Low	
00	High	110 words to be read
6E	Low	
12	High	CRC
DA	Low	

Response example:

01 04 DC

53FDED84 10BB 10DF 10FB 0058 0058 0058 10BB 10DF 10FB
 53FDEDC0 10CC 10E2 10F9 0058 0058 0059 10CC 10E2 10F9
 53FDEDFC 10EA 10FF 1114 0058 0059 0059 10EA 10FF 1114
 53FDEE38 10E8 10F9 1119 0058 0059 0059 10E8 10F9 1119
 53FDEE74 10EB 10FD 112E 0058 0059 0059 10EB 10FD 112E
 53FDEEB0 1101 110C 112A 0059 0059 0059 1101 110C 112A
 53FDEEEC 10DE 1104 111B 0058 0059 0059 10DE 1104 111B
 53FDEF28 10F5 1106 112B 0058 0059 0059 10F5 1106 112B
 53FDEF64 10EC 10FF 111C 0058 0059 0059 10EC 10FF 111C
 53FDEFA0 10FF 110A 112A 0059 0059 0059 10FF 110A 112A
 7B51

Example	Byte	Description
01	-	Slave address
04	-	Function code
DC	-	220 data bytes
53	High	27 th August 2014, 14:39:00 record block
FD	Low	
ED	High	
84	Low	
10	High	0,932 kW system imported active power MIN (+P _{ΣMIN})
BB	Low	
10	High	0,939 kW system imported active power AVG (+P _{ΣAVG})
DF	Low	
10	High	0,945 kW system imported active power MAX (+P _{ΣMAX})
FB	Low	
00	High	0,019 kW system imported reactive power MIN (+Q _{ΣMIN})
58	Low	
00	High	0,019 kW system imported reactive power AVG (+Q _{ΣAVG})
58	Low	
00	High	0,019 kW system imported reactive power MAX (+Q _{ΣMAX})
58	Low	
10	High	0,932 kW system imported apparent power MIN (+S _{ΣMIN})
BB	Low	
10	High	0,939 kW system imported apparent power AVG (+S _{ΣAVG})
DF	Low	
10	High	0,945 kW system imported apparent power MAX (+S _{ΣMAX})
FB	Low	
53	High	27 th August 2014, 14:40:00 record block
FD	Low	
ED	High	
C0	Low	
10	High	0,935 kW system imported active power MIN (+P _{ΣMIN})
CC	Low	
7B	High	CRC
51	Low	

6.2 MODBUS TCP

The following tables show some writing examples in MODBUS TCP. Values contained in Command, Query and Response messages are in hex format.

WIRING MODE SETUP

Command example: 01000000000B0110203C00020400000003

Example	Byte	Description
01	-	Transaction ID
00	High	Protocol ID
00	Low	
00	High	
00	Low	
0B	-	11 data bytes
01	-	Unit ID
10	-	Function code
20	High	Starting register
3C	Low	
00	High	2 words to be written
02	Low	
04	-	4 bytes to be written
00	High	Set 1 phase wiring mode
00	Low	
00	High	
03	Low	

Response example: 0100000000060110203C0001

Example	Byte	Description
01	-	Transaction ID
00	High	Protocol ID
00	Low	
00	High	
00	Low	
06	-	6 data bytes
01	-	Unit ID
10	-	Function code
20	High	Starting register
3C	Low	
00	High	Command successfully sent
01	Low	

DATE&TIME SETUP

Command example: 0100000000B0110204A000204522E5FD4

Example	Byte	Description
01	-	Transaction ID
00	High	Protocol ID
00	Low	
00	High	
00	Low	
0B	-	11 data bytes
01	-	Unit ID
10	-	Function code
20	High	Starting register
4A	Low	
00	High	2 words to be written
02	Low	
04	-	4 bytes to be written
52	High	Set 9 th September 2013, 23:55:00
2E	Low	
5F	High	
D4	Low	

Response example: 0100000000060110204A0001

Example	Byte	Description
01	-	Transaction ID
00	High	Protocol ID
00	Low	
00	High	
00	Low	
06	-	6 data bytes
01	-	Unit ID
10	-	Function code
20	High	Starting register
4A	Low	
00	High	Command successfully sent
01	Low	

RECORDING DOWNLOAD FOR BASIC INSTRUMENT VERSION

1° STEP: prepare data for downloading

Command example: 0100000000B0110F0000002040000001

Example	Byte	Description
01	-	Transaction ID
00	High	Protocol ID
00	Low	
00	High	
00	Low	
0B	-	11 data bytes
01	-	Unit ID
10	-	Function code
F0	High	Starting register
00	Low	
00	High	2 words to be written
02	Low	
04	-	4 bytes to be written
00	High	Prepare data for downloading
00	Low	
00	High	
01	Low	

Response example: 0100000000060110F0000001

Example	Byte	Description
01	-	Transaction ID
00	High	Protocol ID
00	Low	
00	High	
00	Low	
06	-	6 data bytes
01	-	Unit ID
10	-	Function code
F0	High	Starting register
00	Low	
00	High	Command successfully sent
01	Low	

2° STEP: perform the data download by a reading command

Query example: 0100000000060104F101006C

Example	Byte	Description
01	-	Transaction ID
00	High	Protocol ID
00	Low	
00	High	
00	Low	
06	-	6 data bytes
01	-	Unit ID
04	-	Function code
F1	High	Starting register
01	Low	
00	High	108 words to be read
6C	Low	

Response example:

01 00000000 DB 01 04 D8

53FDAEF0 05FC 0000 05FB 0000 05FA 0000 05FB 0000 002E 0000 002D 0000 0030 0000 002F 0000
 53FDAF2C 0955 0000 0953 0000 0953 0000 0954 0000 003C 0000 003C 0000 003F 0000 003D 0000
 53FDAF68 10BB 0000 10B9 0000 10B8 0000 10BA 0000 0057 0000 0057 0000 005B 0000 0059 0000
 53FDAFA4 10C4 0000 10C2 0000 10C1 0000 10C2 0000 0057 0000 0057 0000 005B 0000 0059 0000
 53FDAFE0 10BF 0000 10BD 0000 10BC 0000 10BE 0000 0057 0000 0058 0000 005C 0000 0059 0000
 53FDB01C 10C1 0000 10BF 0000 10BE 0000 10BF 0000 0057 0000 0058 0000 005C 0000 0059 0000

Example	Byte	Description	
01	-	Transaction ID	
00	High	Protocol ID	
00	Low		
00	High		
00	Low		
DB	-	219 data bytes	
01	-	Unit ID	
04	-	Function code	
D8	-	216 reading bytes	
53	High	27 th August 2014, 10:12:00 record block	
FD	Low		
AE	High		
F0	Low		
05	High	0,111 kW phase 1 imported active power AVG (+P1 _{AVG})	1 ST RECORD
FC	Low		
00	High	0 kW phase 1 exported active power AVG (-P1 _{AVG})	
00	Low		
05	High	0,111 kW phase 2 imported active power AVG (+P2 _{AVG})	
FB	Low		
00	High	0 kW phase 2 exported active power AVG (-P2 _{AVG})	
00	Low		
05	High	0,111 kW phase 3 imported active power AVG (+P3 _{AVG})	
FA	Low		
00	High	0 kW phase 3 exported active power AVG (-P3 _{AVG})	
00	Low		
05	High	0,333 kW system imported active power AVG (+P _{ΣAVG})	
FB	Low		
00	High	0 kW system exported active power AVG (-P _{ΣAVG})	
00	Low		
00	High	0,003 kvar phase 1 imported reactive power AVG (+Q1 _{AVG})	
2E	Low		
00	High	0 kvar phase 1 exported reactive power AVG (-Q1 _{AVG})	
00	Low		
00	High	0,003 kvar phase 2 imported reactive power AVG (+Q2 _{AVG})	
2D	Low		
00	High	0 kvar phase 2 exported reactive power AVG (-Q2 _{AVG})	
00	Low		
00	High	0,003 kvar phase 3 imported reactive power AVG (+Q3 _{AVG})	
30	Low		
00	High	0 kvar phase 3 exported reactive power AVG (-Q3 _{AVG})	
00	Low		
00	High	0,010 kvar system imported reactive power AVG (+Q _{ΣAVG})	
2F	Low		
00	High	0 kvar system exported reactive power AVG (-Q _{ΣAVG})	
00	Low		
53	High	27 th August 2014, 10:13:00 record block	2 ND RECORD
FD	Low		
AF	High		
9C	Low		
00	High	0 kvar system exported reactive power AVG (-Q _{ΣAVG})	6 TH RECORD
00	Low		

RECORDING DOWNLOAD FOR ENH INSTRUMENT VERSION

Example with +PΣ, +QΣ, +SΣ parameters enabled for recording.

1° STEP: prepare data for downloading

Command example: 0100000000B0110F0000002040000001

Example	Byte	Description
01	-	Transaction ID
00	High	Protocol ID
00	Low	
00	High	
00	Low	
0B	-	11 data bytes
01	-	Unit ID
10	-	Function code
F0	High	Starting register
00	Low	
00	High	2 words to be written
02	Low	
04	-	4 bytes to be written
00	High	Prepare data for downloading
00	Low	
00	High	
01	Low	

Response example: 0100000000060110F0000001

Example	Byte	Description
01	-	Transaction ID
00	High	Protocol ID
00	Low	
00	High	
00	Low	
06	-	6 data bytes
01	-	Unit ID
10	-	Function code
F0	High	Starting register
00	Low	
00	High	Command successfully sent
01	Low	

2° STEP: perform the data download by a reading command

Query example: 0100000000060104F101006E

Example	Byte	Description
01	-	Transaction ID
00	High	Protocol ID
00	Low	
00	High	
00	Low	
06	-	6 data bytes
01	-	Unit ID
04	-	Function code
F1	High	Starting register
01	Low	
00	High	110 words to be read
6E	Low	

Response example:

01 00000000 DF 01 04 DC

53FDED84 10BB 10DF 10FB 0058 0058 0058 10BB 10DF 10FB
 53FDEDC0 10CC 10E2 10F9 0058 0058 0059 10CC 10E2 10F9
 53FDEDFC 10EA 10FF 1114 0058 0059 0059 10EA 10FF 1114
 53FDEE38 10E8 10F9 1119 0058 0059 0059 10E8 10F9 1119
 53FDEE74 10EB 10FD 112E 0058 0059 0059 10EB 10FD 112E
 53FDEEB0 1101 110C 112A 0059 0059 0059 1101 110C 112A
 53FDEEEC 10DE 1104 111B 0058 0059 0059 10DE 1104 111B
 53FDEF28 10F5 1106 112B 0058 0059 0059 10F5 1106 112B
 53FDEF64 10EC 10FF 111C 0058 0059 0059 10EC 10FF 111C
 53FDEFA0 10FF 110A 112A 0059 0059 0059 10FF 110A 112A

Example	Byte	Description
01	-	Transaction ID
00	High	Protocol ID
00	Low	
00	High	
00	Low	
DF	-	223 data bytes
01	-	Unit ID
04	-	Function code
DC	-	220 reading bytes
53	High	27 th August 2014, 14:39:00 record block
FD	Low	
ED	High	
84	Low	
10	High	0,932 kW system imported active power MIN (+P _{ΣMIN})
BB	Low	
10	High	0,939 kW system imported active power AVG (+P _{ΣAVG})
DF	Low	
10	High	0,945 kW system imported active power MAX (+P _{ΣMAX})
FB	Low	
00	High	0,019 kW system imported reactive power MIN (+Q _{ΣMIN})
58	Low	
00	High	0,019 kW system imported reactive power AVG (+Q _{ΣAVG})
58	Low	
00	High	0,019 kW system imported reactive power MAX (+Q _{ΣMAX})
58	Low	
10	High	0,932 kW system imported apparent power MIN (+S _{ΣMIN})
BB	Low	
10	High	0,939 kW system imported apparent power AVG (+S _{ΣAVG})
DF	Low	
10	High	0,945 kW system imported apparent power MAX (+S _{ΣMAX})
FB	Low	
53	High	27 th August 2014, 14:40:00 record block
FD	Low	
ED	High	
C0	Low	
10	High	0,932 kW system imported active power MIN (+P _{ΣMIN})
CC	Low	
11	High	0,956 kW system imported apparent power MAX (+S _{ΣMAX})
2A	Low	

1ST RECORD

2ND RECORD

10TH RECORD



Innovative Electronic Systems

Via P. Gobetti, 16/F • 28014 Maggiore (NO)
support@algodue.it • www.algodue.com